

OUTSULATION® X™ SYSTEM



An Exterior Wall Insulation and Finish System with Moisture
Drainage That Incorporates Continuous Insulation Utilizing Extruded
Polystyrene Insulation

DS836

Outsulation X System Application Instructions

Table of Contents	
Section I	General Installation Requirements
Section II	Materials Required for Completing Installation of the Outsulation X System
Section III	Mixing Instructions
Section IV	Rough Opening Preparation Options
Section V	Substrate Expansion Joint Bridging Options
Section VI	Sheathing Joints and Fastener Heads
Section VII	Air/Water-Resistive Barrier Application
Section VIII	Accessories
Section IX	Insulation Board Installation
Section X	Installation of Reinforcing Mesh and Base Coat
Section XI	Sealant Joint Preparation
Section XII	Dryvit Primers
Section XIII	Dryvit Finish
Section XIV	Coatings and Sealers
Section XV	Maintenance and Repair

I. General Installation Requirements

A. Project Conditions

1. Storage Dryvit Materials

- a. Materials shall be stored at the job site, and at all times, in a cool, dry location, out of direct sunlight, protected from weather and other sources of damage. Minimum storage temperature shall be as follows:
 - 1) DPR, PMR™, HDP™, Weatherlastic®, and E Finishes™, Color Prime™, and Genesis®: 40 °F (4 °C).
 - 2) For all other products, refer to specific product data sheets.
- b. Maximum storage temperature shall not exceed 100 °F (38° C). **NOTE: Minimize exposure of materials to temperatures over 90 °F (32 °C). Finishes exposed to temperatures over 110 °F (43 °C) for even short periods may exhibit skinning, increased viscosity and should be inspected prior to use.**
- c. Protect all products from inclement weather and direct sunlight.

2. Storage Tremco Materials

- a. Store ExoAir® 230 in original, undamaged packages in a clean, dry, protected location with temperatures 40 °F (4 °C) minimum to 100 °F (38° C) maximum.
- b. Keep product from freezing prior to being applied to the substrate.

3. Application Dryvit Materials

- a. Application of wet materials shall not take place during inclement weather unless appropriate protection is provided. Protect materials from inclement weather until they are completely dry.
 - 1) At the time of Dryvit product application, the air and wall surface temperatures shall be from 40 °F (4 °C) minimum to 100 °F (38° C) maximum for the following products:
 - a) DPR, PMR, HDP, Weatherlastic and E Finishes, Color Prime, and Genesis: 40 °F (4 °C).
 - b) For all other products, refer to specific product data sheets.
 - b. These temperatures shall be maintained with adequate air ventilation and circulation for a minimum of 24 hours (48 hours for Weatherlastic Finishes, Ameristone™, TerraNeo® and Limestone™) thereafter, or until the products are completely dry. Refer to published product data sheets for more specific information.

4. Application Tremco Materials

- a. When applying to surfaces below 40 °F (4 °C), please refer to the Technical Bulletin - Cold Temperature Recommendations for Air Barrier Applications at www.tremcosealants.com or contact Tremco Technical Service at 866-209-2404.

B. Inspection of Substrate

1. Acceptable substrates for application of the Dryvit Outsulation X System are listed in the Dryvit Outsulation X System Specification, [DS835](#).

- a. The substrate must be securely fastened per contract documents.
 - b. The substrate attachment method must comply with all contract documents.
 - c. The substrate must be clean, dry, structurally sound, free of loose material, voids, projections, hot spots, release agents, coatings, or other materials that may affect adhesion.
 - d. There shall be no planar irregularities greater than 1/4 in (6.4 mm) within any 4 ft (1.2 m) radius.
 - e. Wood based sheathings require a 1/8 in (3.2 mm) gap between adjacent sheets per the guidelines published by the APA.
 - f. CMU walls shall have all joints filled and struck flush. Mortar should be cured a minimum of 7 days. Any voids shall be patched with mortar, a non-shrinking grout or other approved patching material.
- #### 2. Prior to applying the Backstop NT - Texture or Backstop NT – Spray over a concrete or masonry substrate, check to ensure that:
- a. All cracks are repaired using appropriate procedures and materials.
 - b. The substrate is structurally sound, free of loose material, voids, projections or other conditions that may interfere with the installation of the Outsulation X System.
 - c. The substrate is clean, dry, free of grease, oil, paint, form release agents, efflorescence and other foreign materials that may inhibit adhesion.
 - d. There are no planar irregularities greater than 1/4 in (6.4 mm) within any 4 ft (1.2 m) radius.
 - 1) Mortar joints that are NOT struck flush or heavily textured masonry units shall be skim coated with Dryvit Genesis prior to the application of Backstop NT – Texture or Backstop NT - Spray.
 - a) Mix Genesis in accordance with Section III.C.1 or III.C.3, respectively.
 - b) With a stainless-steel trowel, apply a coat of the Genesis mixture or Genesis DM mixture over the substrate to fill the mortar joints and surface texture to provide a uniform smooth surface for the application of the Backstop NT material.
 - c) Allow the skim coat to completely dry prior to applying the Backstop NT - Texture or Backstop NT – Spray.

3. ExoAir 230 may be applied to most typical building materials such as exterior sheathing boards, CMU, concrete, exterior grade plywood, OSB and metal surfaces.
 - a. For porous substrate moisture content, please visit www.tremcosealants.com/technical-resources/technical-bulletins.aspx for additional information.

C. Flashing at System Terminations

1. General
 - a. Ensure that flashing is installed in accordance with applicable code requirements and the contract documents. As a minimum, opening preparation is required as shown in the Outsulation X System Installation Details, [DS837](#).
2. Transition at Roof Lines
 - a. Ensure the roof has positive drainage, i.e. all runoff shall be directed to the exterior and away from the structure.
 - b. Roof flashing (by others) shall be installed in accordance with industry guidelines, manufacturer's instructions and contract documents.
 - c. Runoff diverters (i.e. kickouts, crickets and saddles) (by others) shall be installed in accordance with industry guidelines, manufacturer's instructions and contract documents. Particular attention must be paid to the eaves/chimney intersections and sloped roof/wall intersections. Refer to the Dryvit Outsulation X System Installation Details, [DS837](#).
 - d. Hold system a minimum of 8 in (203 mm) above flat roofs; 2 in (51 mm) above sloped roofs.
 - e. Roofing systems shall be capped and sealed, or top of walls protected, in such a way as to eliminate the ability of water to saturate the wall or interior space, both before and after, air barrier system installation. Coordinate installation of the air/water resistive barrier with the roofing trade to ensure compatibility and continuity with the roofing system.
3. Openings
 - a. Heads, jambs and sills of all openings shall be prepared with Dryvit Backstop® NT™, AquaFlash® System, Backstop® Flash & Fill, Tremco Dymonic® 100 or other approved flashing material selected by the design professional prior to window/door, mechanical equipment, or other component installation. For proper application, refer to the Dryvit Outsulation X System Installation Details, [DS837](#).
NOTE: Sill piece shall extend to the inside face of wall and continue a minimum of 4 in (102 mm) up at the jambs.
 - b. Continuous flashing at heads of openings as indicated in contract documents. **NOTE: For windows or doors that do not have integral flashing, a field-applied flashing shall be installed (by others) in accordance with industry guidelines, manufacturer's instructions and contract documents. Refer to the Dryvit Outsulation X System Installation Details, [DS837](#).**
 - c. Individual windows that are ganged to make multiple units require the heads to be continuously flashed and the joints between the units to be fully sealed.
4. Decks and Patios
 - a. Wood decks shall be properly flashed prior to system application. See the Dryvit Outsulation X System Installation Details, [DS837](#).
 - b. Verify that the system terminates above poured decks, patios, landings, etc. and that they are properly sloped and waterproofed to direct water away from the walls.
5. Utilities
 - a. Provisions must be made to ensure that the system terminates properly at lighting fixtures, electrical outlets, hose bibs, dryer vents, etc. Refer to the Dryvit Outsulation X System Installation Details, [DS837](#) for general information and guidance.
6. Grade Level Terminations
 - a. Hold system a minimum of 6 in (152 mm) above finished grade.

D. Sealants

1. Dryvit materials shall be completely dry prior to installation of sealant materials (typically 48 - 72 hours). Humid or cool conditions may require longer drying times.

Notify the general contractor and/or architect and/or owner of all discrepancies. Do not proceed until all unsatisfactory conditions have been corrected.

II. Materials Required for Completing Installation of the Outsulation X System

A. Materials Manufactured or Approved by Dryvit Systems, Inc.

1. AquaFlash and AquaFlash Mesh
2. Backstop Flash & Fill
3. Backstop NT – Texture, Smooth and Spray, or Backstop® DMS
4. Grid Tape™
5. AP Adhesive™
6. TREMGrip®
7. Drainage Strip™ - optional
8. Starter Strip™- optional

- 9. Pre-Coated Starter Boards - optional
- 10. Genesis
- 11. Rapidry™ DM 35-50, Rapidry™ DM 50-75, RapidPatch™
- 12. Standard Plus Mesh, Intermediate Mesh, Panzer® 15, Panzer 20, Corner Mesh, and Detail Mesh®
 - a. It shall be colored blue for product identification bearing the Dryvit logo.
- 13. Dryvit Finishes
- 14. Dryvit Coatings and Primers
- B. Materials Manufactured or Approved by Tremco
 - 1. ExoAir 230
 - 2. Dymonic 100
 - 3. ExoAir 110 AT
 - 4. ExoAir Primer
 - 5. Dymonic® Simple Seal
 - 6. Tremco 2011 Mesh – A mesh that is fully embedded in ExoAir 230 for transition areas

NOTE: Materials listed above are those contained or referenced in the Outsulation X Specification, [DS835](#). Typically, the project specification will identify the specific materials necessary to complete application.

- C. Materials Supplied by Others
 - 1. Portland Cement: Type I or II
 - 2. Clean Potable Water
 - 3. Dryvit/Tremco Approved Extruded Polystyrene Insulation Board

III. Mixing Instructions

- A. General – Dryvit Materials
 - 1. No additives such as sand, aggregates, rapid binders, anti-freeze, accelerators, etc. shall be added to any Dryvit materials under any circumstances. **Such additives will adversely affect the performance of the material and void all warranties.**
- B. Air/Water-Resistive Barrier Materials
 - 1. AquaFlash
 - a. Open the bucket with a utility knife or lid-off.
 - b. AquaFlash is ready to use after an initial spin-up using a “Twister” paddle or equivalent mixing blade, powered by a 1/2 in (12.7 mm) drill, at 450 - 500 rpm. Do not add cement or any other additives.
 - 2. Backstop NT and Backstop NT-VB
 - a. Open the bucket with a utility knife or lid-off.
 - b. Backstop NT and Backstop NT-VB are ready to use after an initial spin-up using a “Twister” paddle or equivalent mixing blade, powered by a 1/2 in (12.7 mm) drill, at 450 - 500 rpm. Do not add cement or any other additives.
 - 3. Backstop DMS (can also be used as adhesive)
 - a. See [DS704](#) for mixing instructions.
 - 4. ExoAir 230 does not require mixing.
- C. Adhesive and Base Coat
 - 1. Genesis
 - a. Open the bucket with a utility knife or lid-off.
 - b. Due to shipping and storage, there may be some separation of materials. Prior to splitting the material and adding Portland cement, mix the material thoroughly. Use a “Twister” paddle or equivalent mixing blade powered by a 1/2 in (12.7 mm) drill, at 500 - 1200 rpm only. **NOTE: A minimum 7 amp drill works best for Portland cement based materials. CAUTION: Do not over-mix or use other types of mixing blades as air entrapment and product damage may occur and result in workability and performance problems.**
 - c. Pour 1/2 of the freshly mixed material [approximately 30 lbs (13.5 kg)] into a clean plastic container.
 - d. Add 1/3 of a bag [approximately 30 lbs (13.5 kg)] of fresh, lump free Type I or II Portland cement. Either gray or white cement is acceptable. Add cement slowly and mix thoroughly. **Do not add large quantities of cement at one time.**
 - e. Clean potable water may be added to the mixture to adjust the workability.
 - 1) Genesis
 - a) Add 1 qt (950 ml) of water prior to adding Portland cement. Additional water may be added to adjust workability.
 - b) Mix the Genesis material with Portland cement thoroughly; then wait five - ten (5 – 10) minutes, then break the initial set. Retempering with a small amount of water is permissible provided the mixture has not set. The mixture has a pot life similar to other Portland cement plaster material. Mix only as much material as can be conveniently used during a work period.

D. Base Coat for High Moisture Areas

1. Dryflex

- a. Open the bucket with a utility knife or lid-off.
- b. Due to shipping and storage, there may be some separation of materials. Prior to splitting the material and adding Portland cement, mix the material thoroughly. Use a “Twister” paddle or equivalent mixing blade, powered by a 1/2 in (12.7 mm) drill, at 500 - 1200 rpm. **NOTE: A minimum 7 amp drill works best for Portland cement-based materials. CAUTION: Do not over-mix or use other types of mixing blades as air entrapment and product damage may occur and result in workability and performance problems.**
- c. Pour 1/2 of the freshly mixed material [approximately 22.5 lbs (10.21 kg)] into a clean plastic container.
- d. Add 1/4 of a bag [approximately 22.5 lbs (10.21 kg)] of fresh, lump free Type I or II Portland cement. Either gray or white cement is acceptable. Add cement slowly and mix thoroughly. **Do not add large quantities of cement at one time.**
- e. Clean potable water may be added to the mixture to adjust the workability. Add as little water as possible, in small increments, and only after the Portland cement is thoroughly mixed. **Do not over-water as this will degrade the performance and promote efflorescence.**
NOTE: It is advisable to mix the Dryflex material with Portland cement thoroughly; allow the mixture to set for five – ten (5 - 10) minutes and mix again to break the initial set. Retempering with a small amount of water is permissible provided the mixture has not set. The mixture has a pot life similar to any Portland cement material. Mix only as much material as can be conveniently used during a work period.

E. One Component Adhesives

1. AP Adhesive and TREMGrip

- a. Mixing is not required.

F. Primers

1. Color Prime™, Color Prime - W™, Primer with Sand™, and Weatherprime®

- a. Mix material with a “Twister” paddle or equivalent mixing blade, powered by a 1/2 in (12.7 mm) drill, at 450 - 500 rpm to a homogeneous consistency.

G. Finish

1. Quarzputz®, Quarzputz® E, Sandblast®, Freestyle®, Sandpebble®, Sandpebble® E, Sandpebble® Fine, Sandpebble® Fine E, HDP Finishes, and Weatherlastic® Finishes.

- a. Thoroughly mix the factory-prepared Dryvit finish with a “Twister” paddle or equivalent mixing blade powered by a 1/2 in (12.7 mm) drill, at 450 - 500 rpm, until a uniform, homogeneous consistency is attained. A small amount of clean potable water may be added to adjust workability. Always add the same amount of water to each pail within a given lot to avoid color variation.

NOTE: If using a tint pack to color finish please refer to Tint Pack Mixing Instructions, [DS750](#).

H. Specialty Finishes

1. Ameristone

- a. Mix Ameristone for approximately one (1) minute to ensure uniformity using a “Twister” paddle or equivalent mixing blade powered by a 1/2 in (12.7 mm) drill, at 450 - 500 rpm, just prior to application. **DO NOT OVERMIX.**
- b. Mix all pails for the same amount of time.
- c. If clean potable water is added as described in [DS142](#) for various application techniques, the same amount must be added to each pail.

2. Stone Mist®

- a. Mix Stone Mist for one (1) minute to ensure uniformity using a “Twister” paddle or equivalent mixing blade, powered by a 1/2 in (12.7 mm) drill, 450 - 500 rpm, just prior to application. **DO NOT OVERMIX.**

3. TerraNeo

- a. Mix TerraNeo for one (1) minute just prior to application, to ensure uniformity using a “Twister” paddle or equivalent mixing blade, powered by a 1/2 in (12.7 mm) drill, at 450 - 500 rpm. **DO NOT OVERMIX.**

4. Limestone

- a. Mix Limestone with a “Twister” paddle or equivalent mixing blade, powered by a 1/2 in (12.7 mm) drill, at 450 - 500 rpm until a uniform workable consistency is attained.

NOTE: If using a tint pack to color finish please refer to Tint Pack Mixing Instructions, [DS750](#).

5. Custom Brick Finishes

- a. For Custom Brick finishes, refer to Dryvit Custom Brick Application Instructions, [DS154](#), for complete mixing instructions.

NOTE: If using a tint pack to color finish please refer to Tint Pack Mixing Instructions, [DS750](#).

6. Finesse™

- a. Mix Finesse with a “Twister” paddle or equivalent mixing blade, powered by a 1/2 in (12.7 mm) drill, at 450 - 500 rpm until a uniform workable consistency is attained.

7. Tibur Stone

- a. Mix Tibur Stone with a “Twister” paddle or equivalent mixing blade, powered by a 1/2 in (12.7 mm) drill, at

450 - 500 rpm until a uniform workable consistency is attained.

8. Reflectit™

a. Refer to Reflectit Data Sheet [DS705](#) and Application Instructions [DS124](#) for complete instructions.

I. Coatings and Sealers

1. Demandit Smooth and Demandit Sanded, HDP Water-Repellent Coating, Weathercoat™, and Weatherlastic® Smooth

a. Mix material with a “Twister” paddle or equivalent mixing blade, powered by a 1/2 in (12.7 mm) drill, at 450 - 500 rpm to a homogeneous consistency.

2. Tuscan Glaze™

a. Mix Tuscan Glaze with a “Twister” paddle or equivalent mixing blade, powered by a 1/2 in (12.7 mm) drill, at 450 - 500 rpm to a homogeneous consistency, immediately prior to application. As an alternate, boxing of buckets is acceptable. **Continuously** agitate throughout application to ensure color consistency.

3. SealClear™

a. Stir material thoroughly before using and stir often during the application process. As an alternate, boxing of buckets is acceptable.

IV. Rough Opening Preparation Options

A. AquaFlash System Option

1. AquaFlash must be installed to provide a continuous barrier from the air/water-resistive barrier/sheathing substrate onto the framing edges at discontinuities and terminations such as openings, expansion joints, tops of parapets, etc. Refer to Dryvit Outsulation X System Installation Details, [DS837](#).

2. Surface Preparation

- a. Apply only when air and surface temperatures are from 40 °F (4 °C) minimum to 100 °F (38 °C) maximum.
- b. The surface to receive the AquaFlash System must be clean, dry, smooth and free of any condition that will hinder adhesion.
- c. Clean loose dust or dirt from the surface by wiping with a clean, dry cloth or brush.

3. AquaFlash System Application

a. Rough Openings (Windows, Doors, Others)

- 1) Cut AquaFlash Mesh to proper length [rough opening plus 4 in (102 mm)] extending 2 in (51 mm) past each jamb – Figure 1.

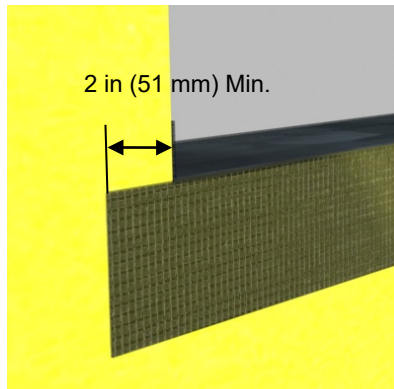

Figure 1

- 2) Begin at the sill of an opening. Using a brush or 3/4 in (19 mm) nap roller, apply a liberal coat of AquaFlash Liquid material to the air/water-resistive barrier/substrate surface. **NOTE: The AquaFlash System must extend to the interior face of the wall opening.**

- 3) Immediately lay the AquaFlash Mesh into the wet material and brush smooth adding additional material to completely embed the mesh - Figure 2.

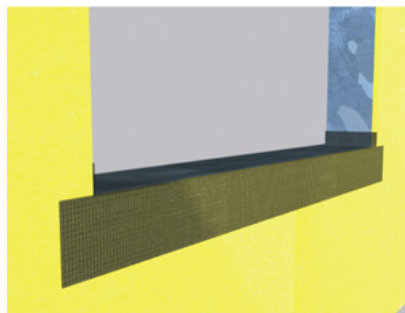

Figure 2

4) Install the AquaFlash System at the jambs in the same manner overlapping onto the sill material a minimum of 2 in (51 mm) – Figure 3.

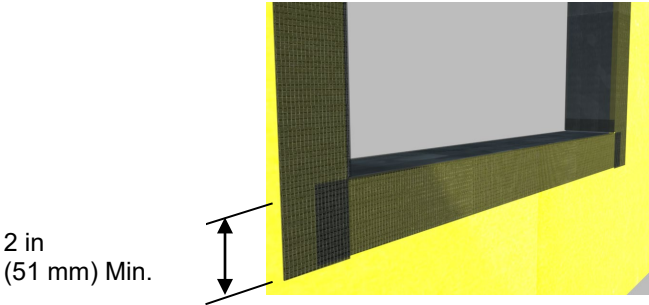

Figure 3

5) Install the AquaFlash System at the head overlapping the jamb pieces a minimum of 2 in (51 mm) – Figure 4.

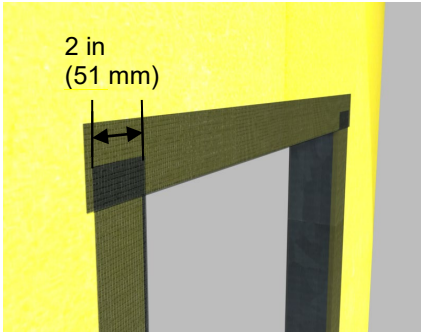

Figure 4

5a) As an alternative, preformed Dryvit AquaFlash Corners can be applied at each corner of the opening to reduce the number of field cuts required. The AquaFlash Corners are installed in the same manner as the AquaFlash Mesh. – Figure 5

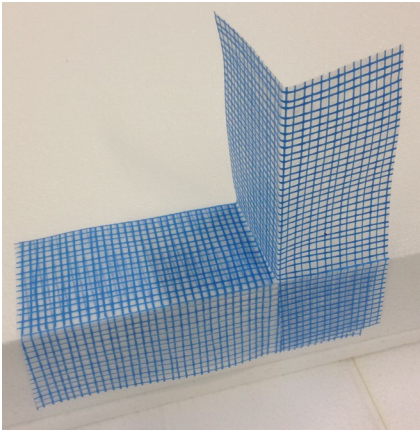

Figure 5

- 6) Install diagonal “butterflies” consisting of AquaFlash Liquid and AquaFlash Mesh at each sill/jamb corner – Figure 6.



Figure 6

- 7) Allow material to set for approximately 15 minutes then apply a second liberal coat of AquaFlash Liquid and smooth out to ensure a continuous film free of voids, pinholes, or other discontinuities.

4. Sill Pan Flashing (Exposed)

- a. Install a watertight pan flashing at all sill locations - Figure 7.
- b. The flashing shall extend between the framing members of the rough opening and shall be sized to protect the sill, sheathing and the surface of the Outsulation X System. It must include vertical legs at the back and sides to ensure proper collection of water. **NOTE: All flashing shall be continuous, have watertight seams, and shall be configured to shed all water to the exterior of the system.**
- c. The flashing shall extend a minimum of 2 1/2 in (64 mm) down over the face of the Outsulation X System - Figure 7.

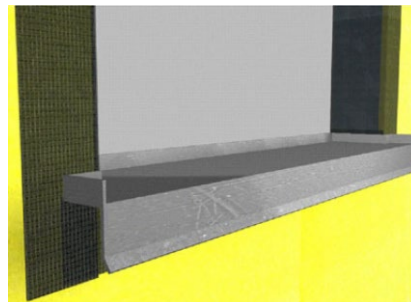

Figure 7

5. Sill Pan Flashing (Concealed) for use with nail-on-windows (refer to Dryvit Outsulation X Installation Details, [DS837](#),

- a. Install a watertight pan flashing at all sill locations.
- b. The flashing shall extend between the framing members of the rough opening and shall be sized to protect the sill and sheathing. It must include vertical legs at the back and sides to ensure proper collection of water. It shall extend a minimum of 4 in (102 mm) below the opening and have a sloped horizontal leg which continues over the top edge of the Outsulation X System. **NOTE: All flashing shall be continuous, have watertight seams, and shall be configured to shed all water to the exterior of the system.**

6. Installation of AquaFlash Over Metal or PVC Flashing Materials

- a. The AquaFlash System may be applied directly over clean galvanized, painted metal, or PVC flashing.
- b. Prepare rough opening as described in Section IV.A.3.
- c. Install flashing material per contract documents.
- d. Clean the surface of the flashing to ensure that it is free of dirt, dust, oil, or other contaminants that may interfere with adhesion. **NOTE: PVC products should be lightly abraded to break the surface skin and provide tooth for the coating.**

- e. Cut AquaFlash Mesh to proper length [flashing plus 4 in (102 mm) extending 2 in (51 mm) beyond each end of flashing] - Figure 8.

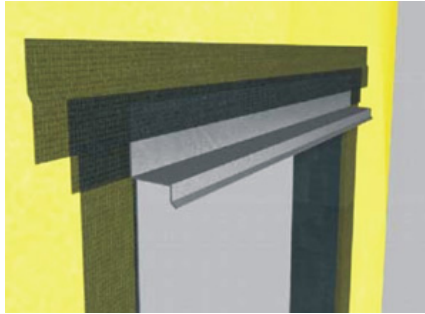

Figure 8

- f. Using a brush or 3/4 in (19 mm) nap roller, apply a liberal coat of AquaFlash Liquid material to the flashing and adjacent air/water-resistive barrier/substrate surface.
- g. Immediately lay the AquaFlash Mesh into the wet material and brush smooth adding additional material to completely embed the mesh.
- h. Allow material to set for 15 minutes then apply a second liberal coat of AquaFlash Liquid and smooth out to ensure a continuous film free of voids, pinholes, or other discontinuities and allow to dry.

B. Dryvit Backstop NT Option

1. Surface Preparation

- a. Apply only when air and surface temperatures are from 40 °F (4 °C) minimum to 100 °F (38 °C) maximum.
- b. The surface to receive the Backstop NT must be clean, dry, smooth and free of any other condition that will hinder adhesion.
- c. Remove loose dust or dirt from the surface by wiping with a clean, dry cloth or brush.

2. Dryvit Backstop NT Application

NOTE: Backstop NT may be applied to the sill of the opening, but it must also be covered with the Dryvit AquaFlash System or Backstop Flash & Fill.

a. Rough Openings (Windows, Doors, Others)

- 1) Apply Dryvit Grid Tape along the jambs and head of the opening as well as all sheathing joints that may intersect the opening and lap onto face of wall a minimum of 2 in (51 mm). Add additional pieces of Grid Tape at the inside corners of the opening to maintain continuity – Figure 9.

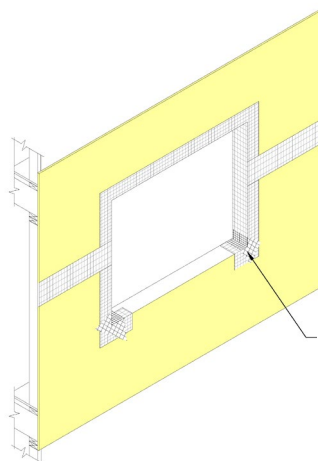
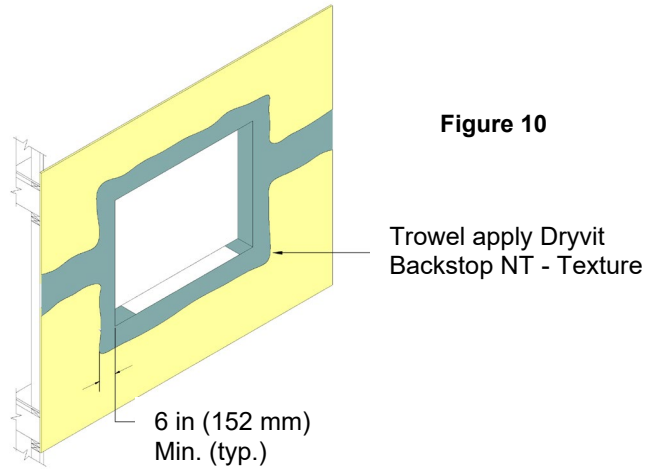

Figure 9

Apply Dryvit Grid Tape at corners

- 2) Using a stainless steel trowel apply Backstop NT – Texture over the Grid Tape extending to the inside face of the opening and onto the face of the exterior sheathing a minimum of 6 in (152 mm) – Figure 10.



- 3) Apply Dryvit AquaFlash System or Backstop Flash & Fill at sill in accordance with Sections IV.A.3. **NOTE: AquaFlash System or Backstop Flash & Fill must extend up the jambs a minimum of 4 in (102 mm) – Figure 11.**

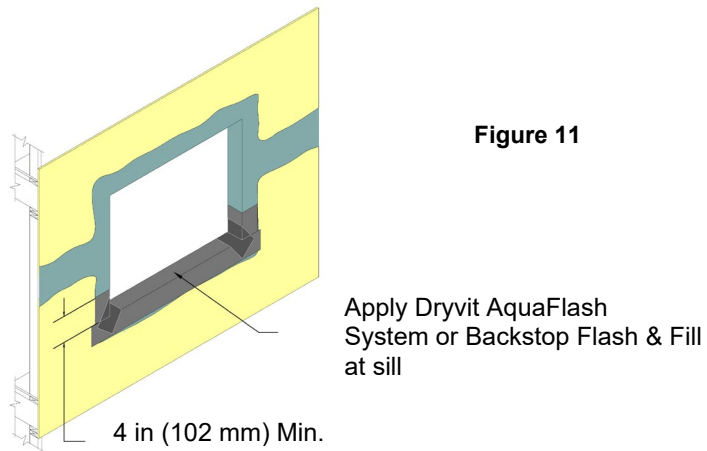

- 4) Install the specified component (i.e. window, etc.) and associated flashings per manufacturer's directions and contract documents. Then apply Backstop NT – Texture, Smooth or Spray to the remainder of the wall surface as described in Section IV.B and lap over the previously installed material around openings – Figure 12.

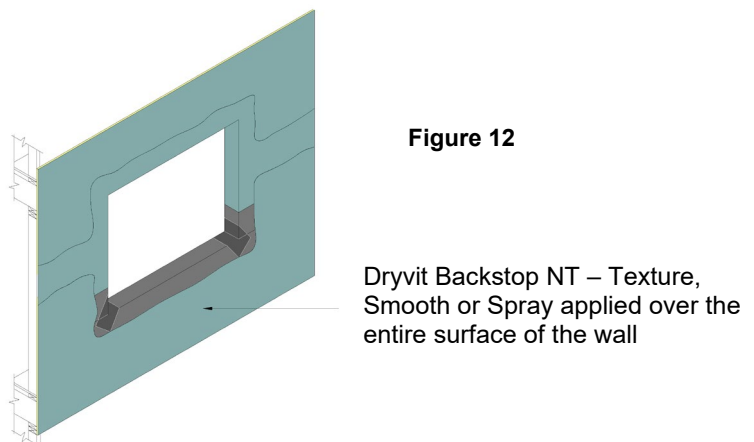

C. Backstop Flash & Fill Option

1. Backstop Flash & Fill may be used to treat openings and sheathing joints prior to application of the Backstop NT air/water-resistive barrier.
2. Refer to product Data Sheet DS848 for complete information.

D. Dymonic 100 Option

1. Surface Preparation
 - a. Brush off any dirt or debris that may have collected in the rough opening.
 - b. Fill any voids or gaps in the rough opening with Dymonic 100.
2. Dymonic 100 Application
 - a. Apply a cant bead (minimum of 1/2 in x 1/2 in) of Dymonic 100 onto all vertical to horizontal transitions within the rough opening, where the sill meets the jambs and where the head meets the jambs.
 - b. Apply Dymonic 100 (40 wet mils) into the rough opening in a zig zag pattern so that the sill, jambs and head are properly detailed. Once the sealant is installed, smooth with a trowel to ensure uniform and complete coverage. The job details will indicate the width required for this detailing depending on the depth of the rough opening and the connection to the fenestration – Figure 13.

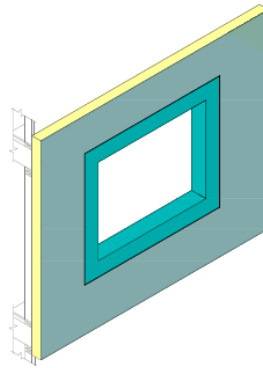

Figure 13

- c. Dymonic 100 can be applied prior to the installation of the ExoAir 230 or Backstop NT membranes or after the ExoAir 230 or Backstop NT membranes. Always provide a minimum of 2 in of product overlap when making these transitions/connections.

V. Substrate Expansion Joint Bridging Options

A. AquaFlash System Option

1. Surface Preparation
 - a. Apply only when air and surface temperatures are from 40 °F (4 °C) minimum to 100 °F (38 °C) maximum.
 - b. The surface to receive AquaFlash System must be clean, dry, smooth and free of any condition that will hinder adhesion.
 - c. Clean loose dust or dirt from the surface by wiping with a clean, dry cloth or brush.

2. AquaFlash System Application

- a. The width of the AquaFlash Mesh must overlap each side of the joint a minimum of 2 in (51 mm) - Figure 14.
- b. Clean the joint to allow for the installation of a backer material. Install a closed cell polyethylene backer rod sized a minimum of 50% larger than the joint width. Install so that the backer rod is recessed or projects a minimum of 1/4 in (6.4 mm) from the wall surface.

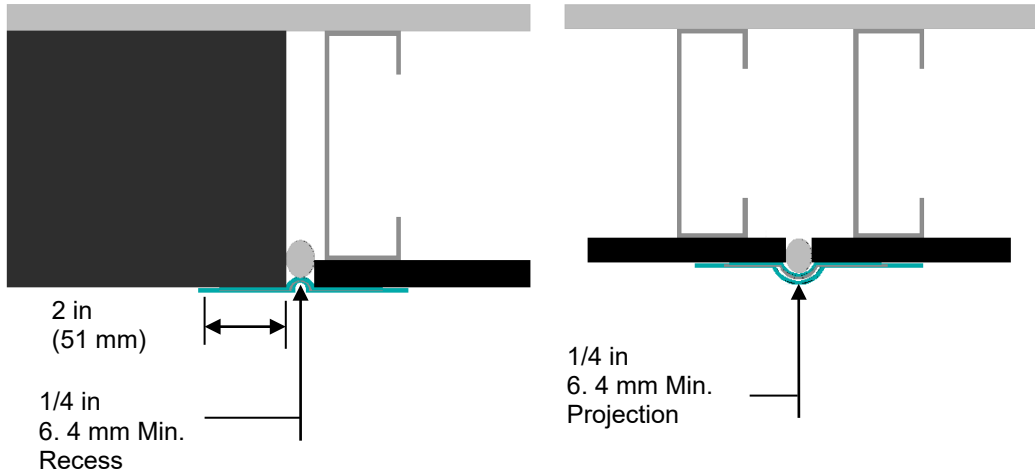

Figure 14

- c. Using a brush or 3/4 in (19 mm) nap roller, apply a liberal coat of AquaFlash Liquid material to the backer rod and adjacent substrate surface to the width of the AquaFlash Mesh - Figure 15.

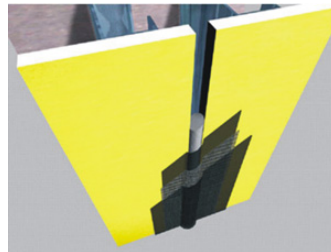

Figure 15

- d. Immediately lay the AquaFlash Mesh into the wet material and brush smooth adding additional material to completely embed the mesh.
- e. Allow material to set for 15 minutes then apply a second liberal coat of AquaFlash Liquid and smooth out to ensure a continuous film free of voids, pinholes, or other discontinuities.

B. Dymonic Simple Seal and Dymonic 100 Option

1. Surface Preparation

- a. Always perform project-specific field testing to verify adhesion of the sealant to the substrates.
- b. Surfaces must be sound, clean, and dry.
- c. Contact surfaces should be free of loose dirt, dust, oils, and any other contaminants.
- d. Tremco recommends that air temperature be 40°F (4°C) or above before applying any sealant

2. Dymonic 100 Sealant and Dymonic Simple Seal Application

- a. Apply a continuous bead of Dymonic 100 sealant in a straight line along the edge of the bonding substrate. The sealant should be sufficiently wide enough that when the Dymonic Simple Seal is applied, the ridges on the material are completely encapsulated in sealant.
- b. Unroll a length of Dymonic Simple Seal approximately the length of the joint to be spanned. Install the Dymonic Simple Seal material with caution to avoid stretching the extrusion as it is embedded into the sealant.
- c. As Dymonic Simple Seal is unrolled, ensure that a clean surface exists at the bonding area. If necessary, utilize the two-cloth cleaning method with xylene to clean the bonding surface of Dymonic Simple Seal

- d. Align the Dymonic Simple Seal so that the center of the Simple Seal is over the center of the joint, and the ridges cover the substrate on both sides of the joint. Care should be taken to ensure the ridges have been fully embedded in the sealant.
 - e. Embed the Dymonic Simple Seal in the beads of Dymonic 100 and immediately use a roller to press the extrusion firmly into the polyurethane sealant. If a roller is unavailable or undesirable, a flat, hard material may be substituted and used gently to tap the face of the material, embedding the bonding surface into the sealant.
 - f. Cut the Dymonic Simple Seal extrusion at the end of the joint using a sharp razor blade.
 - g. Sealant that has wetted out from beneath the extrusion should be tooled to minimize visible sealant lines through the coating to achieve the desired appearance.
 - h. [See Sample Sealant Usage Guide on the Tremco Website.](#)
3. Cleaning
- a. Immediately after the application is complete, remove all the excess sealant and smears adjacent to the joint with an approved solvent.
 - b. Avoid contact between the cleaning solvent and the functional sealant bead prior to the sealant bead reaching a full cure. Cleaning solvent should come into contact with smears and excess sealant only.

VI. Sheathing Joints and Fastener Heads

A. Dryvit Backstop NT Texture and Grid Tape Option

- 1. For sheathing substrates, apply the Dryvit Grid Tape along all joints in the sheathing, as well as inside corners, outside corners, and exposed edges at terminations that will not be covered with Dryvit AquaFlash System or Backstop Flash & Fill.
- 2. Center the Dryvit Grid Tape on the sheathing joints, edges, etc. with the pressure sensitive adhesive backing in contact with the sheathing surface. Press into position with hand pressure until adhesion is achieved.
- 3. Apply only enough Dryvit Grid Tape as can be covered with Backstop NT - Texture in the same day.

B. Dryvit Backstop NT - Texture Application

NOTE: Backstop NT Texture is NOT recommended for use over the face of OSB.

- 1. General: Backstop NT - Texture can be applied using a roller, trowel or texture spray equipment over the listed substrates, as noted in the usage chart above. Backstop NT - Texture should be applied at the recommended coverage rate to achieve a continuous film at a minimum dry film thickness of approximately 12 mils (0.3 mm).
- 2. Roller Application
 - a. Apply Dryvit Grid Tape as described in Section VI.A.1 above. Mix the Backstop NT - Texture material as described in Section III.B.2. Using a stainless steel trowel or spatula, apply a layer of Backstop NT - Texture over the Dryvit Grid Tape and spot all fastener heads – Figure 16.

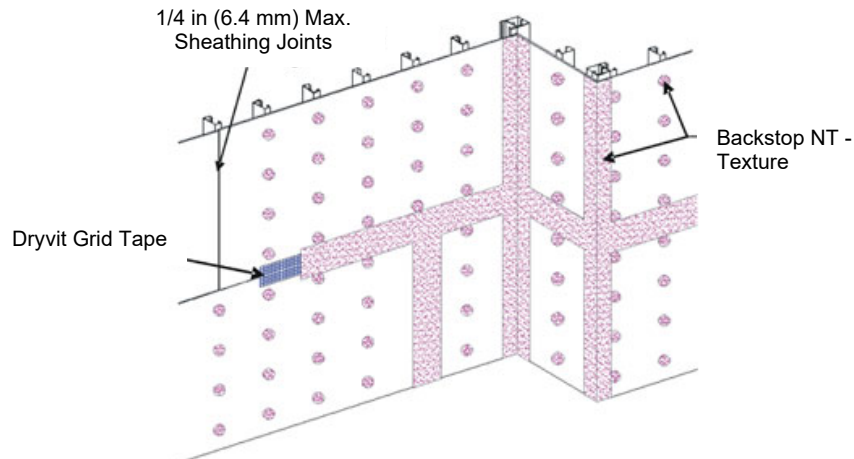

Figure 16

NOTE: Dryvit Grid Tape is not necessary over fastener heads.

- b. Allow to dry for a minimum of 2 hours or until dry to the touch. **NOTE: Cool, humid conditions may require longer drying times**
 - 1) Because of the absorption characteristics, plywood substrates may require a second pass to fill any voids at the sheathing joints. After the first pass has dried, check the joints and spot any voids that may be present with additional Backstop NT – Texture material and allow to dry.

NOTE: OSB sheathing requires that joints and fasteners be treated with Backstop NT - Texture. A minimum of two (2) coats of Backstop NT - Smooth or Backstop NT – Spray are required for the field of the wall. Backstop NT - Texture is not recommended for application in the field of the board.

C. Dryvit AquaFlash Mesh and Backstop NT Smooth

1. Use a 6 in Roller Frame with a 3/8 in – 1/2 in Nap Pad to apply a coat of Backstop NT Smooth centered over the sheathing board joints. Next apply the 4 in AquaFlash Mesh by either rolling or brushing with a 4 in paint brush, another layer of AquaFlash liquid material to completely embed the AquaFlash Mesh.
2. Next, hand spot the fastener heads with Backstop NT Smooth with a pan / putty knife, hawk / putty knife or trowel.
3. Allow sheathing joints, inside / outside corners, & fasteners heads to dry a minimum of 2 hours in average 70-degree temperature & 50% relative humidity.

D. Tremco Dymonic 100 Option

1. General

- a. Surfaces must be sound, clean, and dry. Surfaces should also be free of loose dirt, dust, oils, and any other contaminants.
- b. Using a mil gauge, ensure that a minimum of 40 wet mils have been applied, if not, reapply sealant to achieve 40 wet mils.
 - 1) In Plane Board Joints
 - a) Ensure board joints are in compliance with Section VI.A.1.
 - b) For in plane board joints apply and tool Dymonic 100 sealant ensuring minimum overlap of 3/4 in onto each panel at a 40 mil thickness.
 - c) For intersections of vertical and horizontal board joints, caution should be taken to not remove or disturb existing sealant when overlapping.
 - d) Feather sealant on horizontal joints out onto panel.

c. Inside Corners

- 1) Ensure board joints are in compliance with Section VI.A.1.
- 2) Install minimum 1/2 in wide bond breaker tape centered on joint.
- 3) Apply 1/2 in bead of Dymonic 100 (green) sealant bead over bond breaker tape.
- 4) Tool to achieve cove bead, minimum 1/4 in bond beyond edge of bond breaker tape to panel surface on each side of joint.

d. Outside Corners

- 1) Ensure boards joints are in compliance with section VI.A.1.
- 2) Apply a continuous bead of Dymonic 100 sealant in a zigzag pattern or a straight bead on each side of the joint.
- 3) Tool Dymonic 100 sealant over the corner joint so that sealant grips the substrate a minimum of 1.5 in on both sides.

e. Fastener Heads

- 1) All fastener heads shall be detailed after installation with minimum 40 mils and 3/4 in minimum diameter quantity of Dymonic 100 sealant.

VII. Air/Water-Resistive Barrier Application

A. Dryvit Backstop NT, NT-VB or DMS Option

1. When using Backstop DMS refer to DS704.
2. Ensure that the wall surface and ambient temperature are from 40 °F (4 °C) minimum to 100 °F (38 °C) maximum at the time of Backstop NT application. **WARNING:** Do not apply the Dryvit materials in the rain. The underlying wall materials and substrate surface must be dry prior to applying the air/water-resistive barrier.
3. Sheathing Substrates

a. Prior to applying the Backstop NT over a sheathing substrate, check to ensure that:

- 1) The sheathing is of a type listed in the Outsulation X System Specification, [DS835](#)
- 2) The sheathing is structurally sound, free of loose material, voids, projections or other conditions that may interfere with the installation of the Outsulation X System.
- 3) The sheathing is clean, dry, and free of grease, oil, efflorescence, dust, dirt, paint and other foreign material.
 - a) Exterior grade gypsum sheathing facing paper shall not show signs of deterioration and shall be firmly bonded to the core.
 - b) Plywood or OSB moisture content shall not exceed 19% as measured by a probe type moisture meter.
- 4) There are no planar irregularities greater than 1/4 in (6.4 mm) within any 4 ft (1.2 m) radius.

SHEATHING WITH GAPS OR DAMAGE EXCEEDING 1/4 in (6.4 mm) IN ANY ONE DIRECTION MUST BE REPLACED. NOTE: Notify the general contractor and/or architect and/or owner of all discrepancies. Do not proceed until all unsatisfactory conditions have been corrected.

NOTE: OSB sheathing requires that joints and fasteners be treated with Backstop NT - Texture. A minimum of two (2) coats of Backstop NT - Smooth or Backstop NT – Spray is required for the field of the wall. Backstop NT - Texture is not recommended for application in the field of the board.

4. Concrete or Masonry Substrates

NOTE: Backstop NT - Texture or Backstop NT – Spray is recommended for use over concrete and masonry.

a. Prior to applying the Backstop NT - Texture or Backstop NT – Spray over a concrete or masonry substrate, check to ensure that:

- 1) All cracks are repaired using appropriate procedures and materials.
- 2) The substrate is structurally sound, free of loose material, voids, projections or other conditions that may interfere with the installation of the Outsulation X System.
- 3) The substrate is clean, dry, free of grease, oil, paint, form release agents, efflorescence and other foreign materials that may inhibit adhesion.
- 4) There are no planar irregularities greater than 1/4 in (6.4 mm) within any 4 ft (1.2 m) radius.
 - a) Mortar joints that are NOT struck flush or heavily textured masonry units shall be skim coated with Dryvit Genesis prior to the application of Backstop NT – Texture or Backstop NT - Spray.
 - 1) Mix Genesis in accordance with Section III.C.
 - 2) With a stainless-steel trowel, apply a coat of the Genesis mixture or Genesis DM mixture over the substrate to fill the mortar joints and surface texture to provide a uniform smooth surface for the application of the Backstop NT material.
 - 3) Allow the skim coat to completely dry prior to applying the Backstop NT - Texture or Backstop NT – Spray.

5. Usage Application Chart:

Backstop NT (BSNT) – Texture, Smooth, and Spray Usage/Application Chart				
			Approx. Coverage Per Pail	Approx. Coverage Per Drum
Exterior Grade Gypsum Sheathing				
Joints ^a	BSNT - Texture	Trowel	300 lin. ft (91 m)	
Face ^e	BSNT - Texture	Trowel, FoamPRO #58 Roller ^b or Texture Sprayer	250-300 ft ² (23-28 m ²)	
	BSNT - Smooth ^{c,g}	1/2 in (12.7 mm) Nap Roller or Texture Sprayer	500 ft ² (46 m ²)	
	BSNT - Spray ⁱ	Airless Spray	500-600 ft ² (46-56 m ²)	5,000-6,000 ft ² (465-557 m ²)
Fiberglass Faced Exterior Gypsum Sheathing				
Joints ^a	BSNT - Texture	Trowel	300 lin. ft (91 m)	
Face ^e	BSNT - Texture	Trowel or Texture Sprayer	250-300 ft ² (23-28 m ²) [includes joints]	
	BSNT - Smooth ^{c,g}	3/4 in (19 mm) Nap Roller or Texture	400 ft ² (37 m ²)	
	BSNT - Spray ^g	Airless Spray	500-600 ft ² (46-56 m ²)	5,000-6,000 ft ² (465-557 m ²)
Exposure 1, Exterior Grade, and Fire Retardant Treated Plywood; and Exterior Cement Board				
Joints ^a	BSNT - Texture	Trowel	300 lin. ft (91 m)	
Face ^e	BSNT - Texture	Trowel, FoamPRO #58 Roller ^b or Texture Sprayer	250-300 ft ² (23-28 m ²)	
	BSNT - Smooth ^{c,g}	1/2 in (12.7 mm) Nap Roller or Texture Sprayer	400 ft ² (37 m ²)	
	BSNT - Spray ^g	Airless Spray	500-600 ft ² (46-56 m ²)	5,000-6,000 ft ² (465-557 m ²)
APA Exposure 1 Rated Oriented Strand Board (OSB)				
Joints ^a	BSNT - Texture	Trowel	300 lin. ft (91 m)	
Face ^e	BSNT - Smooth ^g	1/2 in (12.7 mm) Nap Roller or Texture Sprayer	350-400 ft ² (33-37 m ²), applied in 2 coats, backrolled	3,500-4,000 ft ² (325-372 m ²)
	BSNT - Spray ^g	Airless Spray		
Concrete and Masonry^{d,g}				
Face	BSNT - Texture	Trowel ^f	200-250 ft ² (19-23 m ²) ^f applied in 1 coat	
	BSNT - Texture	FoamPRO #58 Roller or Texture Sprayer	200-250 ft ² (19-23 m ²) ^f applied in 2 coats, backrolled	
	BSNT - Spray ^g	Airless Spray	300-500 ft (28-46 m ²)	3,000-5,000 ft (279-465 m ²)

^a Tape the joints with Dryvit Grid Tape prior to application of Backstop NT - Texture at joints and screw heads.
^b Up to 1 pint (16 oz) of water may be added to a 60 lb pail of Backstop NT - Texture for roller or spray applications only. The FoamPRO #58 roller cover (FoamPRO Mfg., Inc., www.foampromfg.com) is available at home supply stores.
^c Because of application methodology and absorptive surface differences, two coats may be required to obtain this coverage.
^d Due to variations in types of concrete/masonry, apply a 6 ft x 6 ft test area with coverage as indicated in the chart, before proceeding with the entire job. If there are voids in the substrate, particularly at the mortar joints, the job should be parged with Genesis[®], 24 hours prior to BSNT - Texture application. Backstop NT shall NOT be used as a skim coat for parging CMU joints or heavy textured units.
^e Backstop NT - Texture (with up to 1 pint water addition per 60 lb. pail) or Smooth may be sprayed and backtrowelled/backrolled.
^f Coverage may vary depending on the texture and porosity of the substrate. Coverage assumes a smooth, dense surface.
^g Backstop NT should be applied at the recommended coverage rates to form a continuous film free of voids, pinholes or other discontinuities. The following approximate mil thicknesses are recommended:
 Backstop NT Texture 12 DFT 20* WFT
 Backstop NT Smooth 12 DFT 20* WFT
 Backstop NT Spray 9 DFT 15* WFT
 *Based on volume solids

Refer to Product Data Sheets for Complete Mixing and Application Instructions

6. Application of Backstop NT

- a. Once board joints and fasteners have been treated (see Section VI) apply Backstop NT.
- b. Dryvit Backstop NT - Texture Application

NOTE: Backstop NT Texture is NOT recommended for use over the face of OSB.

- 1) General: Backstop NT - Texture can be applied using a roller, trowel or texture spray equipment over the listed substrates, as noted in the usage chart above. Backstop NT - Texture should be applied at the recommended coverage rate to achieve a continuous film at a minimum dry film thickness of approximately 12 mils (0.3 mm).
 - 2) Roller Application
 - a) Use a coarse, open-cell foam roller cover with a 3/8 in (9.5 mm) foam nap (FoamPRO #58 roller). Apply a uniform, continuous film of Backstop NT – Texture over the entire surface of the sheathing, concrete or masonry, including the previously treated areas. **NOTE: If the roller pulls material back out of the sheathing joints, it indicates that the joint material is not sufficiently dry.**
 - b) For concrete and masonry, ensure that a continuous film of uniform thickness is applied across the entire surface and across mortar joints. Minimum 2 coats are required allowing a minimum of 2 hours between coats. Cool, damp weather may require longer time between coats.
 - c) While the Backstop NT - Texture is still wet, using a trowel or spatula, smooth out the Backstop NT - Texture around all window and door perimeters.
 - d) The Backstop NT - Texture material should be applied in a uniform, continuous film at the recommended coverage rate. **NOTE: Substrates with a surface texture or high porosity will require additional material.**
 - 3) Trowel Application
 - a) Using a stainless-steel trowel, apply a continuous coating of Backstop NT - Texture material onto the entire surface. The material should be applied at a smooth, uniform, continuous film approximately equal to the thickness of the aggregate.
 - 4) Spray/Back-Rolling Application
 - a) Because of the absorption characteristics, plywood substrates may require a second pass to fill any voids at the sheathing joints. After the first pass has dried, check the joints and spot any voids that may be present with additional Backstop NT - Texture material and allow to dry.
 - b) Using a handheld hopper gun or other suitable texture spray equipment; spray a layer of Backstop NT - Texture onto the wall surface. Using a coarse, open-cell foam roller cover with a 3/8 in (9.5 mm) foam nap (FoamPro #58 roller), roll the material to create a smooth continuous film. **NOTE: If the roller pulls material back out of the sheathing joints, it indicates that the joint material is not sufficiently dry.**
 - c) Backstop NT - Texture material should be applied in a uniform, continuous film at the recommended coverage rate. **NOTE: Substrates with a surface texture or high porosity will require additional material.**
 - 5) Allow the Backstop NT – Texture to completely dry prior to installation of the Outsulation X System
- c. Backstop NT - Smooth Application
 - 1) General: Dryvit Backstop NT - Smooth can be applied using a roller or sprayed and back-rolled over the acceptable sheathing substrates. **NOTE: OSB sheathing requires that joints and fasteners be treated with Backstop NT - Texture. A minimum of two (2) coats of Backstop NT - Smooth or Backstop NT – Spray is required for the field of the wall. Backstop NT - Texture is not recommended for application in the field of the board.**
 - 2) Roller Application
 - a) Using the appropriate nap roller (see Usage Application Chart), apply the Backstop NT - Smooth over the entire wall surface, including previously treated joints. **NOTE: If the roller pulls material back out of the sheathing joints, it indicates that the joint material is not sufficiently dry.**
 - b) Backstop NT - Smooth material should be applied in a uniform, continuous film at the recommended coverage rate – Figure 17. **NOTE: Sheathing substrates with a surface texture or high porosity will require additional material.**

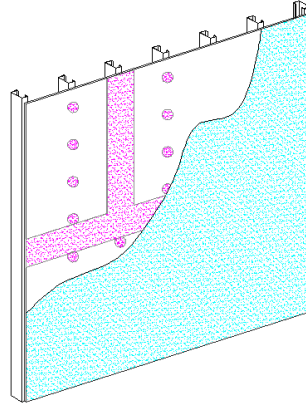

Figure 17

3) Spray/Back-Rolling Application

- a) Backstop NT - Smooth may be applied to the wall using a hopper gun or texture spray equipment and back-rolled using the appropriate nap roller (see Usage Application Chart).
- b) Allow the Backstop NT – Smooth to completely dry, check the wall to ensure that the Backstop NT - Smooth is continuous and touch up any visible voids with additional Backstop NT - Smooth material.
- c) Allow the Backstop NT – Smooth to completely dry prior to installation of the Outsulation X System.

d. Backstop NT - Spray Application

- 1) General: Dryvit Backstop NT - Spray can be applied using appropriate spray equipment over the acceptable sheathing substrates.

- a) Airless spray equipment must be capable of providing minimum 3000 psi and minimum material flow of 1 gallon per minute with a minimum .021 spray tip.

NOTE: OSB sheathing requires that joints and fasteners be treated with Backstop NT - Texture. A minimum of two (2) coats of Backstop NT - Spray are required for the field of the wall. Backstop NT - Texture is not recommended for application in the field of the board.

- 2) Sheathing Substrates: All fastener heads shall be spotted, and joints treated with Backstop NT - Texture and Dryvit Grid Tape in accordance with Section IV prior to Backstop NT - Spray application.

- a) Backstop NT - Spray material should be applied in a uniform, continuous film at the recommended coverage rate free of voids and pinholes. **NOTE: Sheathing substrates with a surface texture or high porosity will require additional material.**

3) Concrete/Masonry Substrates

- a) Backstop NT - Spray may be applied to the wall using appropriate airless spray equipment and back-rolled using the appropriate nap roller (see Usage Application Chart).
- b) Allow the Backstop NT - Spray to completely dry, check the wall to ensure that the Backstop NT - Spray is continuous and touch up any visible voids with additional material.
- 4) Allow the Backstop NT - Spray to completely dry prior to installation of the Dryvit EIF system.

G. Tremco Materials

1. Tremco ExoAir 230 Option

- a. Using a minimum 3/4 in (19 mm) nap roller or spray applicator, ExoAir 230 is to be applied at 48 wet mils (33 ft²/gal; 3.07 M²/US gal) on exterior glass-mat sheathing and 70 wet mils (23 ft²/gal; 2.13 M²/US gal) on porous substrates. Please refer to the Technical Bulletin Spraying Guide at www.tremcosealants.com for more information on spraying ExoAir 230.
- b. Use a wet film mil gauge as well as staging of material to ensure proper application thickness.
- c. When transitioning onto ExoAir self-adhered membranes, Dymonic 100 shall be used to detail the edges of the ExoAir self-adhered membranes prior to the installation of ExoAir 230.
- d. If detail work is being done after the air barrier membrane has been installed, seal around penetrations with an additional coat of ExoAir 230, or detail with Dymonic 100.
- e. Protect membranes to avoid damage by other trades and construction materials during subsequent operations. Insulation and/or protection products may be installed after membranes have cured, 16 to 24 hr following application, or firm and dry to the touch.
- f. Connect the ExoAir Air Barrier System to the adjacent building envelope systems such as the roof membrane, below-grade waterproofing membrane, window and curtain wall systems and other portions of the building envelope using the recommended Tremco materials. For more information on those materials and application details, please visit www.tremcosealants.com.
- g. Schedule work so that the air barrier system is covered as soon as possible after installation. If the air barrier system cannot be covered within 12 months after installation, apply temporary UV protection. Contact

Tremco Technical Service for additional recommendations at 866-209-2404 or visit the Technical Resources area of our website at www.tremcosealants.com and "Ask the Expert."

2. Coverage of Tremco ExoAir 230 and Dymonic 100
 - a. ExoAir 230
 - 1) Exterior Sheathing: minimum 48 wet mils (25 dry mils); 33 ft²/gal (3.07 m²/US gal).
 - 2) Porous Substrates: minimum 70 wet mils (35 dry mils); 23 ft²/gal (2.13 m²/US gal).
 - b. Dymonic 100

Total Lineal inches (add width into rough opening and onto face of wall) (inches/cm)	Mil Thickness	Use per cartridge (feet/meter)	Use per sausage (feet/meter)
6/15.24	40	5/1.5	9.8/3
5/12.7	40	6/1.8	11.8/3.6
4/10.16	40	7.4/2.2	14.7/4.5
3/7.62	40	10/3	19.7/6

VIII. Accessories

- A. Installation of the Dryvit Drainage Strip or pre-coated Starter Boards
 1. Dryvit Drainage Strip (Optional - not required when pre-coated Starter Boards are specified)
 - a. Dryvit Drainage Strip shall be used at the base of the walls and shall be installed at the heads of all penetrations and at expansion/control joints as shown in Outsulation X Installation Details, [DS837](#).
 - b. Using a chalk line, strike a level line at the base of the wall, head of opening or expansion/control joint to use as reference in applying the Dryvit Drainage Strip.
 - c. Install the Dryvit Drainage Strip by applying dabs of Dryvit's AP Adhesive at 12 in (305 mm) on center on the dry Backstop NT air/water-resistive barrier.
 - d. Position the Dryvit Drainage Strip on the chalk line and press firmly against the substrate to ensure firm contact between the adhesive and the wall surface. Staples or other fasteners may be used if necessary, to maintain position until the insulation board is installed.
 2. Pre-coated Starter Boards (Optional - not required when Dryvit Drainage Strip or Drainage Track are specified)
 - a. Pre-coated Starter Boards shall be used at the base of walls as shown in Detail No. OPMD 0.0.01a
 - b. Using a stainless-steel trowel, apply the adhesive vertically with a notched trowel.
 - c. Press the Starter Board at the base of the wall firmly.

IX. Insulation Board Installation

- A. System Terminations
 1. Attach Detail Mesh around the perimeter of all openings, penetrations, and other system terminations by stapling or applying a ribbon of adhesive mixture on the substrate and embedding the Detail Mesh into the wet mixture.

NOTE: Back wrapping is not required at the base of the wall when using the pre-coated Starter Boards.
 2. Position the Detail Mesh so that a minimum of 2 1/2 in (64 mm) will extend onto the face of the insulation board. Keep the mesh, which is not embedded, clean.
- B. Inspection of the Insulation Board
 1. Prior to installing the insulation board, it shall be checked to ensure that:
 - a. the extruded polystyrene insulation board is Dryvit/Tremco approved and is obtained from Dryvit Systems, Inc. or its authorized distributors.
 - b. The insulation board shall have factory planed faces.
 - c. The insulation board pieces shall be delivered in 2ft (0.6 m) by 4 ft (1.2 m) lengths with a minimum thickness of 1 in (25.4 mm).
 - d. The insulation 2 ft (0.6 m) by 4 ft (1.2 m) insulation board pieces shall meet the following tolerances:
 - 1) Length: Plus or minus 1/16 in (1.6 mm).
 - 2) Width: Plus or minus 1/16 in (1.6 mm).
 - 3) Thickness: Plus or minus 1/16 in (1.6 mm). For boards greater than 1 in (25 mm), plus 1/16 in (1.6 mm) minus 0 for boards less than or equal to 1 in (25 mm).
 - 4) Squareness: Shall not deviate from square by more than 1/32 in (0.8 mm) in 12 in (305 mm) of total length or width.
 - 5) Edge Trueness: Shall not deviate more than 1/32 in (0.8 mm) in 12 in (305 mm).
 - 6) Face Flatness: Shall not exhibit any bowing of more than 1/32 in (0.8 mm) in the length.

WARNING: Any insulation board not meeting the above requirements should be rejected and not installed.
- C. Methods of Applying the Dryvit Adhesive
 1. Mix the Dryvit adhesive in accordance with Section III.C
 - a. Cementitious Adhesive
 - 1) Notched Trowel Method

- a) With a notched trowel, 3/8 in (9.5 mm) wide, 1/2 in (12.7 mm) deep notches spaced 1 1/2 in (38 mm) apart, apply the adhesive mixture to the backside of the insulation board. Holding the trowel at a 45° angle, apply firm pressure to the insulation board in order to scrape the excess adhesive from between the adhesive beads. **NOTE: Apply the adhesive so that the ribbons run vertically when the insulation board is placed on the wall.**
- b. Non-cementitious Adhesive
 - 1) AP Adhesive - recommended for use in limited areas only, such as metal surfaces, including steel lintels, metal flashing, etc.
 - a) Cut the smallest opening possible in spout (just large enough so adhesive can flow easily when gunned). It is intended to be applied in thin beads [approximately 3/8 in (9.5 mm)].
 - 1) TREMGrip
 - a) Apply in vertical ribbons spaced 7 1/2" (191 mm) apart, starting 1 1/2:" (38 mm) from the edge of the board, as shown in Figure 18.

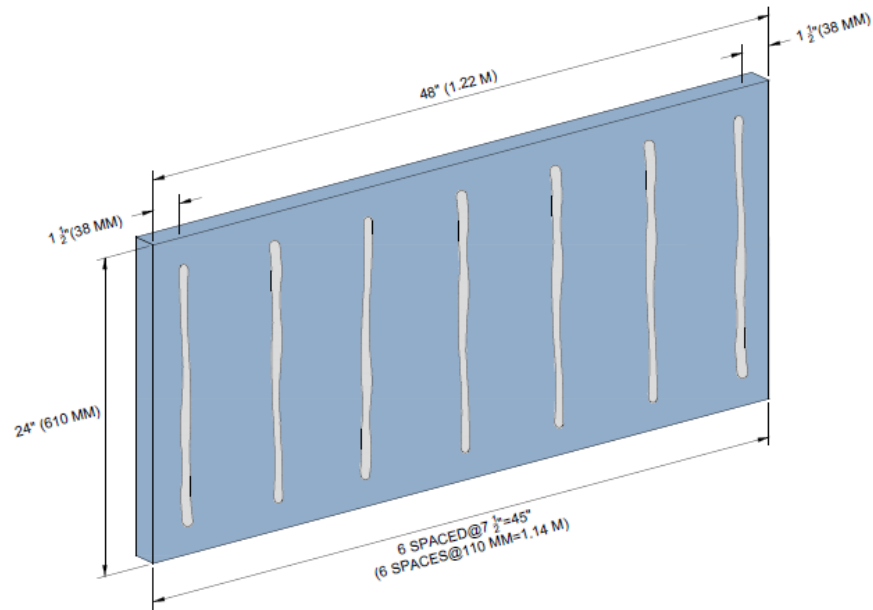

Figure 18

D. Insulation Board Installation

1. Prior to installing the insulation board, ensure that the surface of the Backstop NT is uniform in thickness, continuous, clean, dry and free of any foreign materials that will affect adhesion of the insulation board.
2. Begin installation of the insulation board from a permanent or temporary support.
3. When sheathing is used as a substrate, use a 12 in (305 mm) high by 4 ft (1.2 m) long piece of insulation board as a starter row at the base of the wall. This will help minimize the insulation board joints from coinciding with the sheathing joints. Offset the insulation board joints from the sheathing joints a minimum of 8 in (203 mm) in both vertical and horizontal directions. Install the insulation boards with their long edges oriented horizontally.
4. Apply the adhesive to the insulation board as described in Section IX.
 - a. When using Primus, Genesis, Primus DM, Genesis DM, or Genesis DMS as the adhesive, butter the edge of the insulation board at all terminations in order to properly embed the previously installed Detail Mesh used for back wrapping. Back wrapping is necessary to provide appropriate fire performance and to create the proper surface for application of sealant. **NOTE: The application of the adhesive mixture to the edge of the insulation board is only done when wrapping with the Detail Mesh.**
 - b. Genesis DMS may be applied to the substrate surface in a vertical notched trowel pattern as described in Section IX.D.1.a.1). Refer to Genesis DMS Data Sheet, [DS471](#).
5. Position the insulation board horizontally on the substrate. Press the board gently to the substrate and slide it into position. Apply firm pressure over the entire surface of the insulation board to ensure uniform contact and high initial grab.

6. Using a margin trowel, clean the insulation board edges of any adhesive mixture. Ensure that the insulation board joints are butted tightly, and faces are level and flush. **CAUTION: Do not allow adhesive to remain in board joints.**
7. Immediately install fasteners through the insulation board and into the structural substrate. Install minimum one fastener every stud as shown in the Outsulation X System Installation details, DS837. Fasteners along outside corners and other system terminations shall be spaced not more than 12 in (304.8 mm) apart. Fasteners shall be installed snug to the face of the insulation board with the surface of the washer flush with the insulation board surface. NOTE: Do not overdrive the fasteners or have them projecting above the surface of the insulation board
8. Install subsequent rows of insulation board in a running bond pattern (vertical joints staggered).
9. With factory edges exposed, stagger vertical joints at inside and outside corners. Make sure the corners are straight and plumb.
10. To ensure an overall flat surface, tamp the insulation board surface with a board that overlaps two to four rows of insulation.
11. If for any reason the insulation board joints are not butted tightly, slivers of insulation board must be installed to fill any gaps. ALL GAPS GREATER THAN 1/16 in (1.6 mm) MUST BE SLIVERED. **Tip: In order to create a tight fit, it is recommended that a wider joint be cut with a hot groover or similar tool to allow for a more precise fitting sliver. Do not install adhesive on sliver edges.**
12. Windows, Doors, Mechanical Equipment and all Wall Penetrations
 - a. At openings, align the insulation boards so that the edges (vertical and horizontal joints) do not coincide with the corners of the opening (refer to Dryvit Outsulation X System Installation Details, [DS837](#)).
 - b. Attach Detail Mesh around the perimeter of the opening as described in Section IX.A.
 - c. Hold the insulation board back from the window/door frame or mechanical equipment to allow for differential movement, proper system edge preparation, and sealant installation as shown in the Dryvit Outsulation X System Installation Details, [DS837](#).
13. Expansion Joints
 - a. Attach Detail Mesh around the perimeter of the opening as described in Section IX.A.
 - b. When abutting dissimilar materials, leave a minimum 3/4 in (19 mm) separation between the insulation board and abutting material to allow for differential movement, proper system edge preparation and sealant installation.
 - c. When the Outsulation X System is installed at a substrate transition, leave a minimum 3/4 in (19 mm) separation between the insulation boards to allow for differential movement, proper system edge preparation and sealant installation.
14. **IMPORTANT:** Once the insulation board and Detail Mesh are in place, wait a minimum of 24 hours prior to working on the surface of the insulation board to prevent any movement which may weaken the bond of the adhesive mixture to the substrate. **NOTE: Be sure to protect the installed insulation board from rain, freezing or inclement weather for a period of 24 hours.**
15. Any irregularities in the insulation board surface must be sanded flat. Sanding is accomplished with a light circular motion. **The entire wall area must be sanded.** Use grade 20 grit sandpaper or coarser, in conjunction with hand, electric or air rasps. **NOTE: Do not sand parallel to the insulation board joints. CAUTION: The contractor shall take precautions to contain EPS dust from rasping operation in accordance with contract documents. Use of vacuum rasps are recommended to minimize introduction of EPS dust into the environment.**
16. Remove all loose pieces of insulation board and dust from the sanding operation using a brush, broom, or compressed air. Use OSHA required masks to protect against inhaling EPS dust.
17. All Detail Mesh that was previously installed for back wrapping the insulation board shall be embedded in the base material mixture at this time.
 - a. With a stainless-steel trowel, apply Genesis material mixture to the face (and edge if not previously coated) of the insulation board and embed the Detail Mesh in the wet mixture.
18. Aesthetic Reveals
 - a. To install an aesthetic reveal, snap a straight line using a chalk line to mark the position.
 - b. Position a straight edge such as a steel stud or track against the insulation board in the proper location to guide the appropriate cutting tool (router, hot knife, or hot groover). **CAUTION: The thickness of the insulation board in the bottom of the reveal must not be less than 3/4 in (19 mm).**
 - c. Use Detail Mesh to ensure continuity of reinforcing mesh through aesthetic reveals continuing a minimum of 2 1/2 in (64 mm) on each side of the reveal.
 - 1) Apply the base material mixture in the reveal and on the adjacent insulation board surfaces.
 - 2) Embed the Detail Mesh into base coat mixture on one side of the reveal only.
 - 3) Use a sled or special tool configured to the profile of the reveal. Embed the Detail Mesh into the base coat mixture through the reveal being careful not to cut the mesh.
 - 4) Embed the Detail Mesh into the base coat mixture on the other side of the reveal. Ensure that the mesh is fully embedded and that all excess material is removed from the reveal.
 - 5) Using a damp brush, smooth out any irregularities in the base coat.

CAUTION: If the mesh is cut in the reveal, a new piece of mesh must be installed over the cut.

19. Where Corner Mesh is specified for additional impact resistance at outside corners, the Corner Mesh shall be embedded in the base coat mixture and allowed to set prior to installing the overall reinforced base coat over the face of the wall.
20. Corners of all openings such as windows, doors, mechanical equipment and all penetrations shall be reinforced with Detail Mesh placed diagonally to the opening as illustrated in Figure 19.

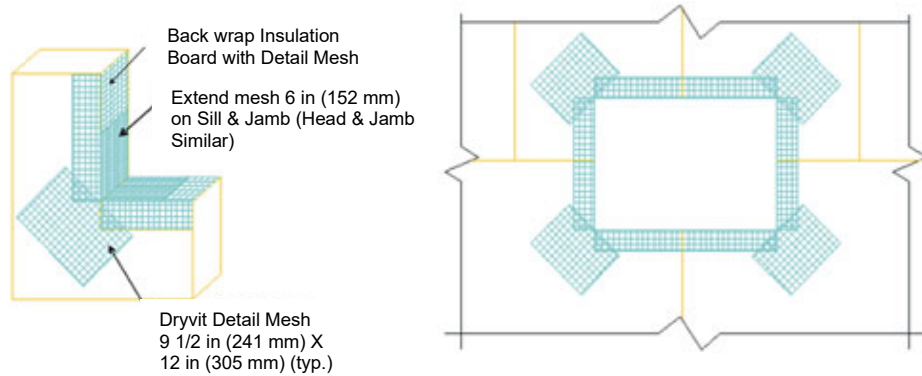

Figure 19

X. Installation of Reinforcing Mesh and Base Coat

A. General

1. **Do not apply the Dryvit materials in the rain. The insulation board must be dry prior to applying the base coat material.**
2. Prior to installing the reinforced base coat, inspect the surface of the insulation board for:
 - a. Flatness: Use a minimum 8 ft (2.4 m) straight edge. Sand any high areas and out-of-plane board joints flat, as described in Section IX.E.1 and 16. **CAUTION: Do not build up low areas with base coat mixture to form a flat surface.**
 - b. Damage and foreign materials: correct deficiencies, as necessary.
 - c. Surface degradation due to weathering or UV, visible as discoloration. Sand affected areas to remove deterioration while maintaining the flatness of the surface.

B. Mix the base coat material as described in Section III.C and D.

C. Prior to installing the reinforcing mesh, it should be inspected to ensure that it has been furnished by Dryvit Systems, Inc.

1. Dryvit reinforcing mesh is available in the following widths and lengths:
 - a. Standard Plus, and Intermediate - 48 in x 150 ft (1.2 m x 45.7 m)
 - b. Panzer 15 - 48 in x 75 ft (1.2 m x 22.9 m)
 - c. Panzer 20 - 48 in x 75 ft (1.2 m x 22.9 m)
 - d. Corner - 9 1/4 in x 150 ft (235 mm x 45.7 m)
 - e. Detail - 9 1/2 in x 150 ft (241 mm x 45.7 m)
2. It shall be colored blue for product identification bearing the Dryvit logo.

D. Installation of Dryflex base coat in high exposure areas such as sloped surfaces, windowsills, etc.

1. Using a stainless-steel trowel, apply the Dryflex mixture on the surface of the insulation board in a uniform thickness of approximately 3/32 in (2.4 mm). Apply the Dryflex continuously over the sloped surface and continue minimum 6 in (152 mm) onto the vertical areas.
2. Immediately place the reinforcing mesh against the wet Dryflex mixture. With the curve of the mesh against the wall, trowel from the center to the edges, avoiding wrinkles, until the mesh is fully covered and not visible. The overall minimum base coat thickness shall be sufficient to **fully embed** the reinforcing mesh. The recommended method is to apply the base coat in two (2) passes.

NOTE: The reinforcing mesh can be continued across the transition from Dryflex base coat to standard base coat.

3. Allow the Dryflex to cure a minimum of 24 hours or until dry.

E. Base Coat Application

1. Standard Base Coat (single layer of Standard Plus or Intermediate Reinforcing Mesh)
 - a. Spot all fastener heads with Genesis mixture base material so they are flush with the surrounding insulation board surface, and allow to set until firm to the touch.
 - b. The base coat shall be applied using the double pass method such that the reinforcing mesh is fully embedded and the Genesis mixture applied at the recommended coverage of 120 sf/ pail (11.1m²).
 - c. Double pass method

- 1) Using a stainless-steel trowel, apply the base coat mixture on the entire surface of the insulation board to an area slightly larger than the width and length of a piece of reinforcing mesh, in a uniform thickness of 1/8 in (3.2 mm) to 3/16 in (4.7 mm). **NOTE: The reinforcing mesh may be installed either vertically or horizontally.**
- 2) Immediately place the reinforcing mesh against the wet base coat mixture. With the curve of the mesh against the wall, trowel from the center to the edges avoiding wrinkles, until the mesh is fully embedded and not visible. Trowel smooth to a uniform thickness slightly more than the thickness of the reinforcing mesh. **NOTE: The reinforcing mesh shall be continuous at corners and mesh edges lapped not less than 2 1/2 in (64 mm). Do not lap the reinforcing mesh within 8 in (203 mm) of a corner. Tip: Corners and edges normally require light strokes with a small damp brush to smooth out irregularities.**
- 3) Allow the base coat mixture to take up until firm to the touch. Trowel a second tight coat of the base coat mixture over the first coat to **fully cover** the reinforcing mesh - Figure 20. The result should be such that the reinforcing mesh is approximately centered within the base coat thickness. Do not allow the first pass to completely dry prior to the second pass application or an excessive amount of base coat mixture will be necessary to fully coat the wall surface.

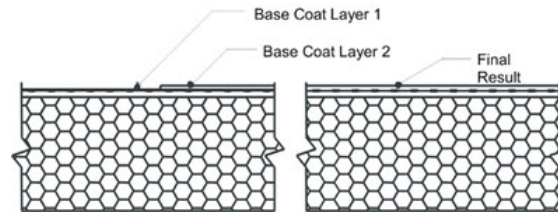

Figure 20

- d. Protect completed work from water penetration and runoff.
- e. Allow the base coat to cure a minimum of 24 hours before proceeding with application of finish coat. Cool, damp conditions may require longer drying times. Do not apply finish to a wet or damp base coat.
2. Panzer Mesh Base Coat (Panzer 15 or Panzer 20 used in conjunction with Standard Plus Reinforcing Mesh). **Panzer Mesh is recommended for use at all ground floor locations and at high traffic areas. Refer to contract documents.**
 - a. Spot all fastener heads with Genesis mixture base material so they are flush with the surrounding insulation board surface, and allow to set until firm to the touch.
 - b. Using a stainless steel trowel, apply the base coat mixture on the entire surface of the insulation board to an area slightly larger than the width and length of a piece of reinforcing mesh, in a uniform thickness of approximately 1/8 in (3.2 mm).
 - c. Immediately place the reinforcing mesh against the wet base coat mixture. With the curve of the mesh against the wall, trowel from the center to the edges avoiding wrinkles until the mesh is fully covered and not visible.
 - d. Continue in the same manner until the entire area requiring Panzer Mesh is covered. **CAUTION: Do not lap the Panzer Mesh. Adjacent pieces are to be tightly butted.**
 - e. Protect completed work from water penetration and runoff.
 - f. Allow the Panzer base coat to cure a minimum of 24 hours prior to applying Dryvit's Standard or Standard Plus Reinforcing Mesh.
 - g. Apply the second layer of reinforcing mesh in accordance with Section X.E.1.c. Offset the edges of the Standard or Standard Plus Reinforcing Mesh from the edges of the Panzer Mesh a minimum of 8 in (203 mm). **Tip: If Panzer Mesh is installed horizontally, we recommend the Standard or Standard Plus Mesh be installed vertically and vice versa.**

XI. Sealant Joint Preparation

- A. All Outsulation X base coat surfaces which will be in contact with sealant must be coated with either Color Prime or Demandit Smooth.
 1. Mix Color Prime or Demandit Smooth in accordance with Section III.F and I respectively.
 2. Using a small brush, apply Color Prime or Demandit to the base coat surface that is to be in contact with the sealant and extending to the joint edge.
 3. Allow the Color Prime or Demandit Smooth to dry a minimum of 48 hours prior to applying the sealant primer and sealant. Cool damp weather may require longer drying times.
 4. Refer to sealant manufacturer's installation instructions for the proper application of the sealant.

XII. Dryvit Primers

- A. Prior to applying the Dryvit primers, the base coat shall have cured a minimum of 24 hours and shall be dry and hard. Cure time may be longer depending on environmental conditions. **NOTE: Refer to Product Data Sheets when applying over other materials.**
- B. Inspect the base coat for any irregularities such as trowel marks, board lines, rough corners and edges, improper reinforcing mesh embedment as well as efflorescence. **NOTE: Correct all irregularities and remove all efflorescence prior to applying the Dryvit primer.**
- C. Mix Dryvit Primers to a smooth homogeneous consistency in accordance with Section III.F.
- D. Color Prime and Weatherprime
 - 1. Apply with a brush, roller, or airless spray equipment. Refer to Color Prime or Weatherprime data sheets, [DS410](#) or [DS436](#), respectively for complete instructions.
- E. Color Prime W
 - 1. Application with airless spray equipment is recommended. Refer to Color Prime W data sheet, [DS474](#) for complete instructions.
- F. Primer with Sand
 - 1. Application with a roller is recommended. Refer to Primer with Sand data sheet, [DS477](#) for complete instructions.

XIII. Dryvit Finish

- A. Prior to applying the Dryvit finish, the base coat shall have cured a minimum of 24 hours and shall be dry and hard. Cure time may be longer depending on environmental conditions.
- B. Inspect the base coat for any irregularities such as trowel marks, board lines, rough corners and edges, improper reinforcing mesh embedment as well as efflorescence. **NOTE: Correct all irregularities and remove all efflorescence prior to applying the Dryvit finish.**
- C. General
 - 1. Important: All Dryvit finishes must be installed continuously to a natural break such as corners, expansion joints, or tapeline. Mechanics must maintain a wet edge. Whenever possible, order enough material in a single batch to complete the project to avoid potential color variations from batch to batch. Sufficient personnel and scaffolding must be provided to continuously finish a distinct wall area or otherwise cold joints will result. Scaffolding must be spaced a minimum of 18 in (458 mm) from the wall to prevent staging lines. On hot windy days, the wall may be fogged with clean potable water to cool the wall and facilitate finish installation. As with other plaster materials, installation work should precede the sun. For example, work the shady or cool side of the building. If this is not possible, scaffold should be shaded with a tarp or nursery shade cloth. Do not introduce water to the finish material once it is installed on the wall. This will cause color variations. Each mechanic must use the same tool and hand motion and match the texture of the mechanics above, below and on each side. Use finish from a single batch number whenever possible.
 - 2. Do not apply Dryvit materials in the rain. The base coat must be dry prior to applying the Dryvit finish or coatings.
 - 3. Do not apply textured Dryvit finish material in sealant joints. Refer to Section XI for proper sealant joint preparation.
- D. Application
 - 1. Mix the Dryvit finishes as described in Section III.
 - 2. Quarzputz, Quarzputz **E**, Quarzputz HDP, Sandblast, Sandblast HDP, Weatherlastic Quarzputz
 - a. Using a clean stainless-steel trowel, apply a coat of the Dryvit finish in a uniform thickness on the dry base coat. **NOTE: The Dryvit Quarzputz finish shall be applied and leveled to a uniform thickness no greater than the largest aggregate. The Sandblast finish is applied and leveled to a thickness of approximately 1 1/2 times the largest aggregate.**
 - b. The texture is achieved by uniform hand motion and/or tool that produces the texture to match the approved sample. Each mechanic must use the same tool and hand motion to ensure that the texture achieved is uniform over the entire wall area.
 - 3. Sandpebble, Sandpebble **E**, Sandpebble Fine, Sandpebble Fine **E**, Weatherlastic Sandpebble, Weatherlastic Sandpebble, Sandpebble HDP, and Weatherlastic Sandpebble Fine.
 - a. Using a clean, stainless steel trowel, apply an even coat of the finish to a thickness slightly thicker than the largest aggregate size.
 - b. Pull across using a horizontal trowel motion to develop a uniform thickness no greater than the largest aggregate of the material.
 - c. The texture is achieved by a uniform hand floating motion with a clean stainless-steel trowel; wipe the trowel and wet it lightly. Apply light pressure in a circular motion.
 - 4. Freestyle
 - a. Using a clean, stainless steel trowel, apply the Freestyle finish on the base coat in a thickness not greater than 1/16 in (1.6 mm). The texture is either pulled out of this base to a thickness of no greater than 1/4 in (6.4 mm) or the texture may be achieved by adding more Freestyle finish to the base coat using the same

texturing motions that are used with other plaster materials, such as, a skip trowel finish. Numerous other aesthetically pleasing textures can be created to match approved samples. **NOTE: The maximum thickness of Freestyle finish texture shall not exceed 1/4 in (6.4 mm).**

5. Weatherlastic Adobe
 - a. Using a brush, roller or airless spray equipment, apply a coat of color coordinated Color Prime (see Section III.F for mixing instructions) at the recommended coverage to the cured base coat and allow to dry.
 - b. Using a stainless-steel trowel, apply a coat of Weatherlastic Adobe approximately 1/16 in (1.6 mm) to the wall surface. Allow the Weatherlastic Adobe finish to take-up.
 - c. Using a stainless-steel trowel, apply a second coat of Weatherlastic Adobe to obtain the desired texture. **Tip: An atomizing spray bottle may be used to apply a mist of water to the surface in the finishing step.**
6. Specialty Finishes: Ameristone, [DS142](#); Stone Mist, [DS420](#); TerraNeo, [DS481](#); Limestone, [DS472](#); Limestone HDP, [DS811](#); Custom Brick, [DS154](#); Tibur Stone, [DS874](#); Finesse, [DS859](#); Finesse HDP, [DS811](#); Reflectit, [DS124](#); NewBrick, [DS871](#).
 - a. Mix the Specialty finishes as described in Section III.H
 - b. Apply the specialty finishes in accordance with the products' Application Instructions or Data Sheets listed above.

XIV. Coatings and Sealers

- A. Mix coatings and sealers to a smooth homogeneous consistency in accordance with Section III.H.1.
- B. Demandit Smooth and Weathercoat
 1. Apply with a brush, roller, or airless spray equipment.
 2. When applying with a roller, a maximum 3/4 in (19 mm) nap, polyester or polyester blend with nylon or lambswool, with beveled ends and a phenolic core is recommended. An 18 in (458 mm) wide roller frame with a 2 1/4 in (57 mm) inside diameter is also recommended.
 3. Apply in one continuous coat, maintaining a wet edge as the application proceeds to a natural break. The roller cover must be kept fully loaded as the application proceeds. **CAUTION: Do not stretch out the application by rolling with a dry roller. The last leveling roller strokes should always be in the same direction. Do not cut in around openings prior to overall application, but rather, do the cut-in work as the application proceeds.**
 4. Do not allow Demandit Smooth or Weathercoat to dry on roller covers. Roller covers with dried coating do not apply the coating evenly.
 5. Changing color requires the application of two coats.
- C. Demandit Sanded
 1. Apply the Demandit Sanded with a brush or 1/2 in - 5/8 in (12.7 mm – 15.9 mm) nap roller.
 2. Roll or brush in multiple directions and then lightly finish in one direction to ensure that no lap marks remain.
 3. A second coat may be required for heavy textured surfaces or when there is a contrast of colors. Apply the second coat as described in paragraph XIV.B.2 and 3 above. **CAUTION: Do not attempt to apply Demandit Sanded in one heavy coat. Two coats are recommended. Apply the second coat only after the first coat is completely dry. Important: Texture changes will exist after Demandit Sanded is applied over existing Dryvit finishes. The degree of change is a function of the thickness and the number of coats of Demandit Sanded.**
- D. Weatherlastic Smooth
 1. Apply a minimum 11 mils dry film thickness (22 mils wet film thickness). This is achieved by applying the Weatherlastic Smooth in two (2) 11 mil wet coats. Under average drying conditions, 70 °F (21 °C), 50% RH, two (2) hours drying time between coats should be adequate.
 2. For cutting-in and trim, a nylon bristle brush is recommended.
 3. Roller Application
 - a. A minimum 10 in (254 mm) roller cover with a 1 1/4 in - 1 1/2 in (32 mm - 38 mm) nap is recommended.
 - b. Completely saturate the roller cover and keep the roller loaded with coating to avoid foaming. Do not dry-roll or over-roll as this will cause excessive entrapment of air within the coating.
 - c. A second coat is applied in a similar manner after the first coat has adequately dried.
 4. Spray Application
 - a. Application by airless spray equipment or mastic pump and gun allows application of coating at total required application rate with a minimum of stipple or thickness variations.
 - b. Equipment should have the capacity to pump 2 gal (7.6 L) of coating per minute.
 - c. Material hose should be minimum 1/2 in (12.7 mm) inside diameter for spraying coating through more than a 50 ft (15 m) length. Minimum bursting of 800 lbs (3600 N) is recommended. **Tip: Orifice sizes of 0.021 in - 0.032 in (0.53 mm - 0.81 mm) will be required depending on equipment used.**
 - d. Cross apply coating holding spray gun perpendicular to, and approximately 3 ft (1 m) from the wall surface. Avoid excessive material build-up by holding spray gun away from the wall when pulling the trigger, then bringing gun across area to be coated. Maintain a wet edge and avoid starting and stopping in the middle of the wall. Do not attempt to overreach spray pattern as this may result in appearance of irregular spray pattern. Place scaffolding and equipment to facilitate quick application without numerous interruptions.

- e. A 10 % loss from overspray should be anticipated.
- f. Backrolling sprayed areas is recommended to control pinholing on spray applications over porous surfaces.

E. Tuscan Glaze

1. Mix Tuscan Glaze to a smooth homogenous consistency in accordance with Section III.I.2. Continuously agitate throughout application to ensure color consistency.
2. Tuscan Glaze is best applied on large areas using a Hudson-type sprayer or airless spray equipment. For smaller areas, Tuscan Glaze is best applied with a paint pad or, depending on the desired results, a roller, paint brush or sponge. Job site mock-ups are required and should represent the actual job site application techniques.
3. Apply Tuscan Glaze evenly in light strokes. If sagging or running occurs, use a sponge or paint pad to correct immediately. Watch for brush or roller lines. If brush or roller lines appear, use a damp sponge, a paint pad or rag to make them disappear before the Tuscan Glaze starts to dry. The wall may be blotted with a camelback sponge to achieve the desired mottled appearance. Check walls throughout the application to ensure that uniformity and the desired appearance is achieved.

F. SealClear

1. Mix SealClear to a smooth, homogeneous consistency in accordance with Section III.I.3.
2. For application instructions, refer to the SealClear Data Sheet, [DS426](#).

XV. Maintenance and Repair

- A. Refer to DryvitCARE EIFS Repair Procedures, [DS498](#).

DISCLAIMER

Information contained in this document conforms to standard detail and product recommendations for the installation of the Dryvit Outsulation X System products as of the date of publication of this document and is presented in good faith. Dryvit Systems, Inc. assumes no liability, expressed or implied, as to the architecture, engineering or workmanship of any project. To ensure that you are using the latest, most complete information, contact Dryvit Systems, Inc., at:

One Energy Way
West Warwick, RI 02893
(401) 822-4100

Dryvit Systems, Inc.
One Energy Way
West Warwick, RI 02893
(800) 556-7752
www.dryvit.com

For more information on [Dryvit Systems](#) or [Continuous Insulation](#), visit these links.

