



APPLICATION INSTRUCTIONS

OUTSULATION[®] MASONRY VENEER SYSTEM

An Exterior Insulation and Finish System with Moisture
Drainage that incorporates an Air/Water-Resistive
Barrier, Continuous Insulation and a Manufactured
Stone Masonry Veneer Finish
DS976

TABLE OF CONTENTS

Section 1	General Installation Requirements
Section 2	Materials That May Be Required for Completing Installation of the Outsulation Masonry Veneer System
Section 3	Mixing Instructions
Section 4	Rough Opening Preparation Options
Section 5	Substrate Expansion Joint Bridging Options
Section 6	Sheathing Joints and Fastener Heads
Section 7	Air/Water-Resistive Barrier Application
Section 8	Accessories
Section 9	Insulation Board Installation
Section 10	Installation of Reinforcing Mesh and Base Coat
Section 11	Sealant Joint Preparation
Section 12	Manufactured Stone Masonry Veneer
Section 13	Maintenance and Repair

1. GENERAL INSTALLATION REQUIREMENTS

A. Project Conditions

1. Storage Dryvit Materials

- a. Materials shall be stored at the job site, and at all times, in a cool, dry location, out of direct sunlight, protected from weather and other sources of damage. Minimum storage temperature for Primus and Backstop NTX shall be 40 °F (4 °C).
- b. Maximum storage temperature shall not exceed 100 °F (38° C). **NOTE: Minimize exposure of materials to temperatures over 90 °F (32 °C).**
- c. Protect all products from inclement weather and direct sunlight.

2. Storage Tremco Materials

- a. Keep product from freezing prior to being applied to the substrate.

3. Application Dryvit Materials

- a. Application of wet materials shall not take place during inclement weather unless appropriate protection is provided. Protect materials from inclement weather until they are completely dry.
 - 1) At the time of Dryvit Primus application, the air and wall surface temperatures shall be from 40 °F (4 °C) minimum to 100 °F (38° C) maximum.
 - 2) At the time of Dryvit Backstop NTX application, the air and wall surface temperatures shall be from 25 °F (-4 °C) minimum to 100 °F (38° C) maximum.
- b. These temperatures shall be maintained with adequate air ventilation and circulation for a minimum of 24 hours thereafter, or until the products are completely dry. Refer to published product data sheets for more specific information.

4. Application Tremco Materials

- a. When applying to surfaces below 40 °F (4 °C), please refer to the Technical Bulletin - Cold Temperature Recommendations for Air Barrier Applications at www.tremcosealants.com or contact Tremco Technical Service at 866-209-2404.

B. Inspection of Substrate for EIF System Application

1. Acceptable substrates for application of the Outsulation Masonry Veneer System including Backstop NTX are listed in the Outsulation Masonry Veneer System Specification, DS977
2. The substrate must be securely fastened per contract documents.
3. The substrate attachment method must comply with all contract documents.
4. The substrate must be clean, dry, structurally sound, free of loose material, voids, projections, hot spots, release agents, coatings, or other materials that may affect adhesion.
5. There shall be no planar irregularities greater than 1/4 in (6.4 mm) within any 4 ft (1.2 m) radius.
6. Wood based sheathings require a 1/8 in (3.2 mm) gap between adjacent sheets per the guidelines published by the APA.
7. CMU walls shall have all joints filled and struck flush. Mortar should be cured a minimum of 7 days. Any voids shall be patched with mortar, a non-shrinking grout or other approved patching material.

C. Flashing at System Terminations

1. General

- a. Ensure that flashing is installed in accordance with applicable code requirements and the contract documents. As a minimum, opening preparation is required as shown in the Outsulation Masonry Veneer System Installation Details, DS978.
- a. Ensure the roof has positive drainage, i.e. all runoff shall be directed to the exterior and away from the structure.
- b. Roof flashing (by others) shall be installed in accordance with industry guidelines, manufacturer's instructions and contract documents.
- c. Runoff diverters (i.e. kickouts, crickets and saddles) (by others) shall be installed in accordance with industry guidelines, manufacturer's instructions and contract documents. Particular attention must be paid to the eaves/chimney intersections and sloped roof/wall intersections. Refer to the Outsulation Masonry Veneer System Installation Details, DS978.

- d. Hold system a minimum of 8 in (203 mm) above flat roofs; 2 in (51 mm) above sloped roofs.
- e. Roofing systems shall be capped and sealed, or top of walls protected, in such a way as to eliminate the ability of water to saturate the wall or interior space, both before and after, air barrier system installation. Coordinate installation of the air/water resistive barrier with the roofing trade to ensure compatibility and continuity with the roofing system.

2. Openings

- a. Heads, jambs and sills of all openings shall be prepared with Dryvit Backstop® NTX™, and/or AquaFlash®, System, or other approved flashing material selected by the design professional prior to window/door, mechanical equipment, or other component installation. For proper application, refer to the Outsulation Masonry Veneer System Installation Details, DS978.

NOTE: Flashing application at sill shall extend to the inside edge of framing and continue a minimum of 4 in (102 mm) up at the jambs.

- b. Continuous flashing at heads of openings as indicated in contract documents. **NOTE: For windows or doors that do not have integral flashing, a field-applied flashing shall be supplied and installed (by others) in accordance with industry guidelines, manufacturer's instructions and contract documents. Refer to the Outsulation Masonry Veneer System Installation Details, [DS978](#).**
- c. Individual windows that are ganged to make multiple units require the heads to be continuously flashed and the joints between the units to be fully sealed.

3. Decks and Patios

- a. Wood decks shall be properly flashed prior to system application. See the Outsulation Masonry Veneer System Installation Details, [DS978](#).
- b. Verify that the system terminates above poured decks, patios, landings, etc. and that they are properly sloped and waterproofed to direct water away from the walls.

4. Utilities

- a. Provisions must be made to ensure that the system terminates properly at lighting fixtures, electrical outlets, hose bibs, dryer vents, etc. Refer to the Outsulation Masonry Veneer System Installation Details, [DS978](#) for general information and guidance.

5. Grade Level Terminations

- a. Hold system a minimum of 6 in (152 mm) above finished grade.

D. Sealants

1. Dryvit materials shall be completely dry prior to installation of sealant materials (typically 48 - 72 hours). Humid or cool conditions may require longer drying times.
2. Sealants and sealant primers are manufactured and supplied by others. Refer to DS153 for a list of sealants that have been tested by the sealant manufacturer's and found to be compatible with Dryvit products.

Notify the general contractor and/or architect and/or owner of all discrepancies. Do not proceed until all unsatisfactory conditions have been corrected.

2. PRODUCTS THAT MAY BE REQUIRED FOR COMPLETING INSTALLATION OF THE OUTSULATION MASONRY VENEER SYSTEM

A. Products Supplied by Dryvit

1. AquaFlash and AquaFlash Mesh
2. Backstop NTX – Texture or Smooth
3. Grid Tape™
4. Drainage Strip™
5. J Track
6. Primus
7. Intermediate Mesh and Detail Mesh®
 - a. Mesh shall be colored blue for product identification bearing the Dryvit logo.

NOTE: Products listed above are those contained or referenced in the Outsulation Masonry Veneer System Specification, [DS977](#). Typically, the project specification will identify the specific Products and Materials necessary to complete application.

B. Products Manufactured by Tremco and Approved by Dryvit.

1. TREMGrip™
2. Joint Sealants

NOTE: Products listed above are those contained or referenced in the Outsulation Masonry Veneer System Specification, DS977. Typically, the project specification will identify the specific Products and Materials necessary to complete application.

C. Materials Supplied by Others

1. Portland Cement: Type I or II
2. Clean Potable Water
3. Expanded Polystyrene Insulation Board meeting Dryvit document DS131
4. Manufactured Stone Masonry Veneer recognized in a current ICC-ES evaluation report demonstrating compliance with the ICC-ES Acceptance Criteria for Manufactured Stone Masonry Veneer (AC51) and as further defined in Section 11.A herein below.
5. Mortar for joint treatment as defined in Section 12.B. herein below.

3. MIXING INSTRUCTIONS

A. General

1. No additives such as sand, aggregates, rapid binders, anti-freeze, accelerators, etc. shall be added to any Dryvit materials under any circumstances. **Such additives will adversely affect the performance of the material and void all warranties.**

B. Air/Water-Resistive Barrier and Asseccory Component

1. AquaFlash
 - a. Open the bucket with a utility knife or lid-off.
 - b. AquaFlash is ready to use after an initial spin-up using a “Twister” paddle or equivalent mixing blade, powered by a 1/2 in (12.7 mm) drill, at 450 – 500 rpm. Do not add cement or any other additives.
2. Backstop NTX
 - a. Open the bucket with a utility knife or lid-off.
 - b. Backstop NTX is ready to use after an initial spin-up using a “Twister” paddle or equivalent mixing blade, powered by a 1/2 in (12.7 mm) drill, at 450 – 500 rpm. Do not add cement or any other additives.

C. Adhesive and Base Coat

1. Primus
 - a. Open the bucket with a utility knife or lid-off.
 - b. Due to shipping and storage, there may be some separation of materials. Prior to splitting the material and adding Portland cement, mix the material thoroughly. Use a “Twister” paddle or equivalent mixing blade powered by a 1/2 in (12.7 mm) drill, at 500 – 1200 rpm only. **NOTE: A minimum 7 amp drill works best for Portland cement based materials. CAUTION: Do not over-mix or use other types of mixing blades as air entrapment and product damage may occur and result in workability and performance problems.**
 - c. Pour 1/2 of the freshly mixed material [approximately 30 lbs (13.5 kg)] into a clean plastic container.
 - d. Add 1/3 of a bag [approximately 30 lbs (13.5 kg)] of fresh, lump free Type I or II Portland cement. Either gray or white cement is acceptable. Add cement slowly and mix thoroughly. **Do not add large quantities of cement at one time.**
 - e. Clean potable water may be added to the mixture to adjust the workability.
 - 1) Add as little water as possible, in small increments, and only after the Portland cement is thoroughly mixed. Do not over water as this will degrade the performance and promote efflorescence.

- 2) Mix the Primus material with Portland cement thoroughly; then wait ten (10) minutes and mix again to break the initial set. Retempering with a small amount of water is permissible provided the mixture has not set. The mixture has a pot life similar to other Portland cement plaster material. Mix only as much material as can be conveniently used during a work period.

D. Substrate Skim Coat Preparation and Adhesive for Manufactured Stone Masonry Veneer

1. Primus

- a. Open the bucket with a utility knife or lid-off.
- b. Due to shipping and storage, there may be some separation of materials. Prior to splitting the material and adding Portland cement, mix the material thoroughly. Use a “Twister” paddle or equivalent mixing blade powered by a 1/2 in (12.7 mm) drill, at 500 – 1200 rpm only. **NOTE: A minimum 7 amp drill works best for Portland cement based materials. CAUTION: Do not over-mix or use other types of mixing blades as air entrapment and product damage may occur and result in workability and performance problems.**
- c. Mix 30 lbs of Wet Primus with 30 lbs of fresh, lump free Type I or II Portland cement in a five-gallon bucket.
- d. When half the cement has been added, add 8 - 16 fluid oz maximum of water then continue adding the cement.
- e. Separate the mixture into two buckets – 25% in one bucket and 75% in the other.
 - i. The bucket with 25% material is to be used for skimming out the surface of the substrate prior to the adhesion of the Manufactured Stone Masonry Veneer. Add water as needed to obtain the consistency desired to skim. Blend mixture.
 - ii. The bucket with 75% material will be used for the adhesive for the Manufactured Stone Masonry Veneer. **No additional water is added.**
- f. Allow both mixtures to set for a minimum of 10 minutes, mix again to break the initial set.
- g. Environmental conditions and selected Manufactured Stone Masonry Veneer shall dictate the amount of water to be added to the Modified Primus Adhesive. Modified Primus Adhesive must be of a thick and stiff consistency.

4. ROUGH OPENING PREPARATION OPTIONS

A. AquaFlash System Option

1. AquaFlash must be installed to provide a continuous barrier from the air/water-resistive barrier/sheathing substrate onto the framing edges at discontinuities and terminations such as openings, expansion joints, tops of parapets, etc. Refer to Outsulation Masonry Veneer System Installation Details, [DS978](#).
2. Surface Preparation
 - a. Apply only when air and surface temperatures are from 40 °F (4 °C) minimum to 100 °F (38 °C) maximum.
 - b. The surface to receive the AquaFlash System must be clean, dry, smooth and free of any condition that will hinder adhesion.
 - c. Clean loose dust or dirt from the surface by wiping with a clean, dry cloth or brush.
3. AquaFlash System Application
 - a. Rough Openings (Windows, Doors, Others)
 - 1) Cut AquaFlash Mesh to proper length [rough opening plus 4 in (102 mm)] extending 2 in (51 mm) past each jamb – Figure 1.

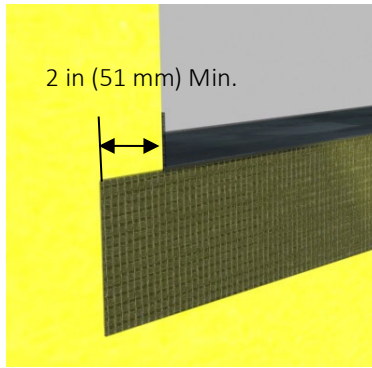

Figure 1

- 2) Begin at the sill of an opening. Using a brush or 3/4 in (19 mm) nap roller, apply a liberal coat of AquaFlash Liquid material to the air/water-resistive barrier/substrate surface.
NOTE: The AquaFlash System must extend to the interior face of the wall opening.
- 3) Immediately lay the AquaFlash Mesh into the wet material and brush smooth adding additional material to completely embed the mesh – Figure 2.

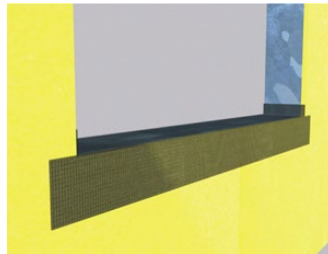

Figure 2

- 4) Install the AquaFlash System at the jambs in the same manner overlapping onto the sill material a minimum of 2 in (51 mm) – Figure 3.

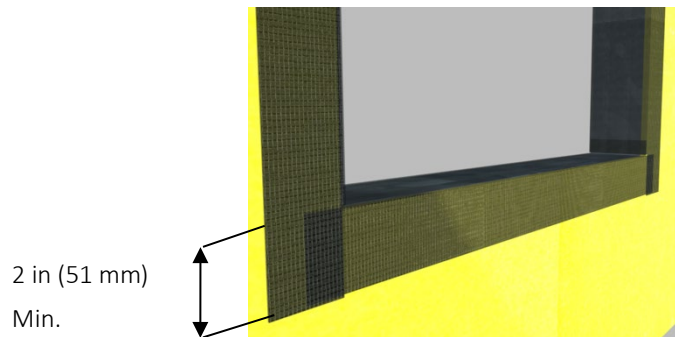

Figure 3

- 5) Install the AquaFlash System at the head overlapping the jamb pieces a minimum of 2 in (51 mm) – Figure 4

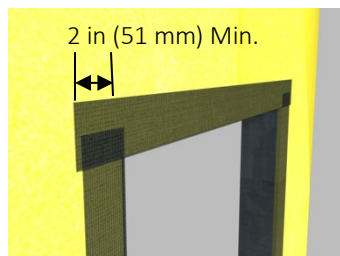

Figure 4

5a). As an alternative, preformed Dryvit AquaFlash Corners can be applied at each corner of the opening to reduce the number of field cuts required. The AquaFlash Corners are installed in the same manner as the AquaFlash Mesh. – Figure 5

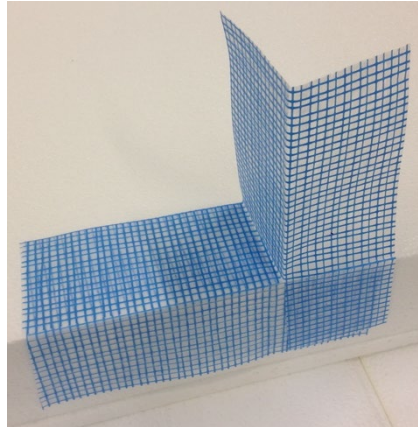

Figure 5

6) Install diagonal “butterflies” consisting of AquaFlash Liquid and AquaFlash Mesh at each sill/jamb corner – Figure 6.

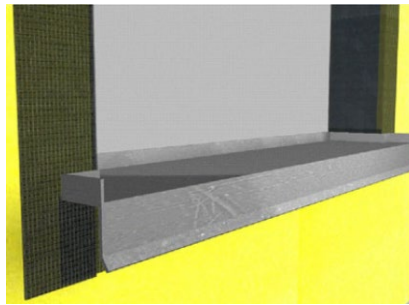

Figure 6

7) Allow material to set for approximately 15 minutes then apply a second liberal coat of AquaFlash Liquid and smooth out to ensure a continuous film free of voids, pinholes, or other discontinuities.

4. Sill Pan Flashing (Exposed)

- a. Install a watertight pan flashing at all sill locations – Figure 7.
- b. The flashing shall extend between the framing members of the rough opening and shall be sized to protect the sill, sheathing and the surface of the Outsulation Masonry Veneer System. It must include vertical legs at the back and sides to ensure proper collection of water. **NOTE: All flashing shall be continuous, have watertight seams, and shall be configured to shed all water to the exterior of the system.**
- c. The flashing shall extend a minimum of 2 1/2 in (64 mm) down over the face of the Outsulation Masonry Veneer System – Figure 7.



2 1/2 in
(64 mm) Min.

Figure 7

5. Sill Pan Flashing (Concealed) for use with nail-on-windows (refer to Outsulation Masonry Veneer System Installation Details, [DS977](#)).
 - a. Install a watertight pan flashing at all sill locations.
 - b. The flashing shall extend between the framing members of the rough opening and shall be sized to protect the sill and sheathing. It must include vertical legs at the back and sides to ensure proper collection of water. It shall extend a minimum of 4 in (102 mm) below the opening and have a sloped horizontal leg which continues over the top edge of the Outsulation Masonry Veneer System. **NOTE: All flashing shall be continuous, have watertight seams, and shall be configured to shed all water to the exterior of the system.**
6. Installation of AquaFlash Over Metal or PVC Flashing Materials
 - a. The AquaFlash System may be applied directly over clean galvanized, painted metal, or PVC flashing.
 - b. Prepare rough opening as described in Section 4.A.3.
 - c. Install flashing material per contract documents.
 - d. Clean the surface of the flashing to ensure that it is free of dirt, dust, oil, or other contaminants that may interfere with adhesion. **NOTE: PVC products should be lightly abraded to break the surface skin and provide tooth for the coating.**
 - e. Cut AquaFlash Mesh to proper length [flashing plus 4 in (102 mm) extending 2 in (51 mm) beyond each end of flashing] – Figure 8.

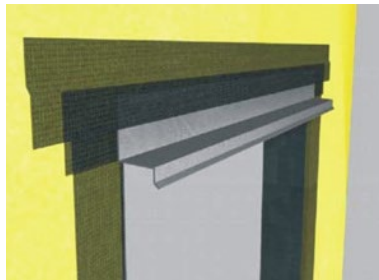

Figure 8

- f. Using a brush or 3/4 in (19 mm) nap roller, apply a liberal coat of AquaFlash Liquid material to the flashing and adjacent air/water-resistive barrier/substrate surface.
 - g. Immediately lay the AquaFlash Mesh into the wet material and brush smooth adding additional material to completely embed the mesh.
 - h. Allow material to set for 15 minutes then apply a second liberal coat of AquaFlash Liquid and smooth out to ensure a continuous film free of voids, pinholes, or other discontinuities and allow to dry.
- B. Dryvit Backstop NTX
1. Surface Preparation
 - a. For Backstop NTX, apply only when air and surface temperatures are from 25 °F (-4 °C) minimum to 100 °F (38 °C) maximum.
 - b. The surface to receive the Backstop NTX must be clean, dry, smooth and free of any other condition that will hinder adhesion.
 - c. Remove loose dust or dirt from the surface by wiping with a clean, dry cloth or brush.
 2. Dryvit Backstop NTX Application

NOTE: BackstopNTX may be applied to the sill of the opening but it must also be covered with the Dryvit AquaFlash System.

a. Rough Openings (Windows, Doors, Others)

- 1) Apply Dryvit Grid Tape along the jambs and head of the opening as well as all sheathing joints that may intersect the opening and lap onto face of wall a minimum of 2 in (51 mm). Add additional pieces of Grid Tape at the inside corners of the opening to maintain continuity – Figure 9.

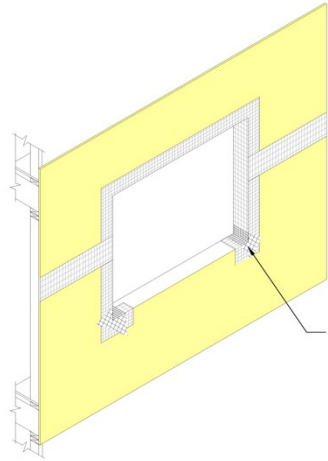

Figure 9

Apply Dryvit Grid Tape at corners

- 2) Using a stainless steel trowel apply Backstop NTX – Texture over the Grid Tape extending to the inside face of the opening and onto the face of the exterior sheathing a minimum of 6 in (152 mm) – Figure 10.

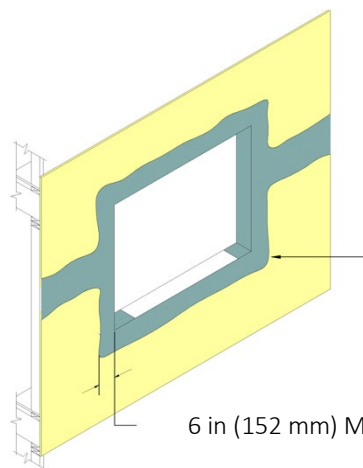

Figure 10

Trowel apply Dryvit Backstop NTX - Texture

6 in (152 mm) Minimum (typ.)

- 3) Apply Dryvit AquaFlash System at sill in accordance with Sections 4.A.3. **NOTE: AquaFlash System must extend up the jambs a minimum of 4 in (102 mm) – Figure 11.**

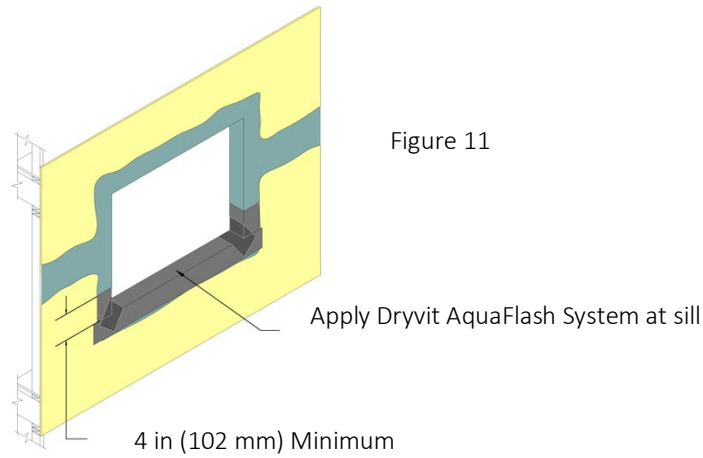

Figure 11

- 4) Install the specified component (i.e. window, etc.) and associated flashings per manufacturer's directions and contract documents. Then apply Backstop NT or NTX – Texture or Smooth to the remainder of the wall surface as described in Section 7 and lap over the previously installed material around openings – Figure 12..

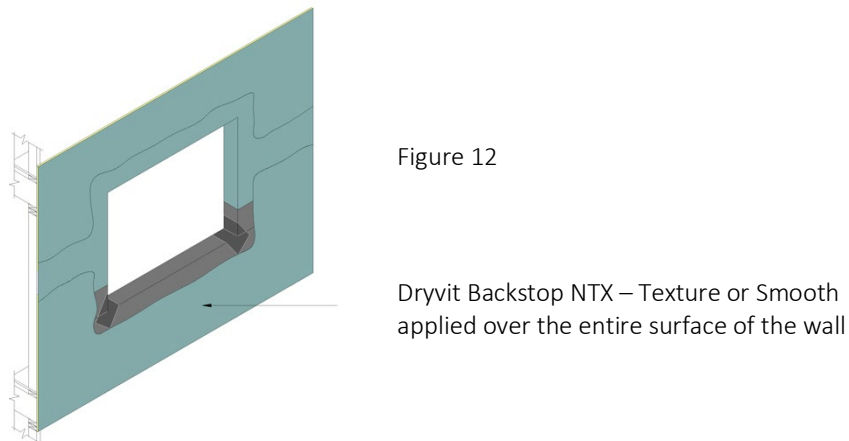

Figure 12

5. SUBSTRATE EXPANSION JOINT BRIDGING OPTIONS

A. AquaFlash System Option

1. Surface Preparation

- a. Apply only when air and surface temperatures are from 40 °F (4 °C) minimum to 100 °F (38 °C) maximum.
- b. The surface to receive AquaFlash System must be clean, dry, smooth and free of any condition that will hinder adhesion.
- c. Clean loose dust or dirt from the surface by wiping with a clean, dry cloth or brush..

2. AquaFlash System Application

- a. The width of the AquaFlash Mesh must overlap each side of the joint a minimum of 2 in (51 mm) – Figure 14.
- b. Clean the joint to allow for the installation of a backer material. Install a closed cell polyethylene backer rod sized a minimum of 50% larger than the joint width. Install so that the backer rod is recessed or projects a minimum of 1/4 in (6.4 mm) from the wall surface.

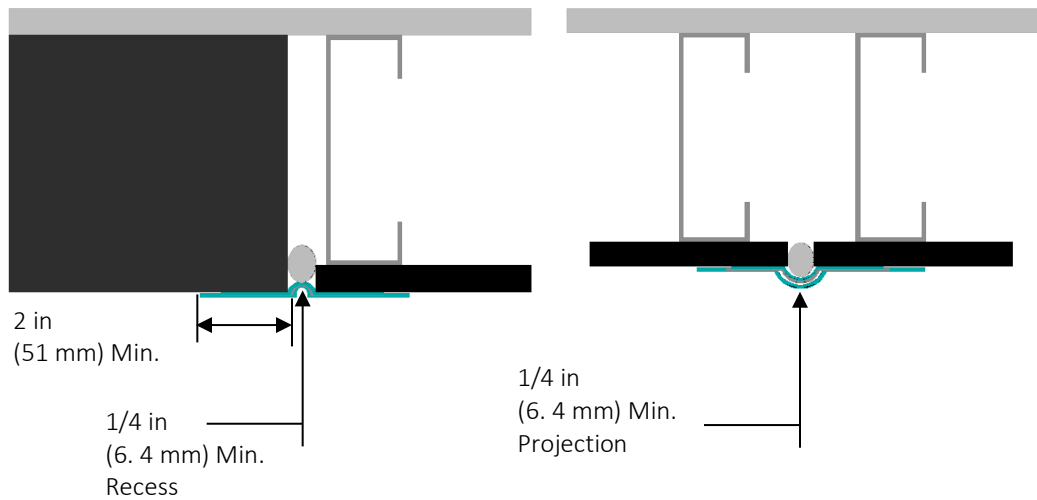

Figure 14

- c. Using a brush or 3/4 in (19 mm) nap roller, apply a liberal coat of AquaFlash Liquid material to the backer rod and adjacent substrate surface to the width of the AquaFlash Mesh – Figure 15.

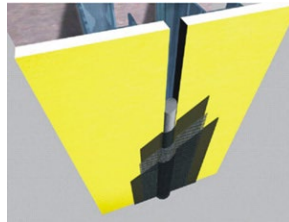

Figure 15

- d. Immediately lay the AquaFlash Mesh into the wet material and brush smooth adding additional material to completely embed the mesh.
- e. Allow material to set for 15 minutes then apply a second liberal coat of AquaFlash Liquid and smooth out to ensure a continuous film
- f. free of voids, pinholes, or other discontinuities.

6. Sheathing Joints and Fastener Heads

A. Dryvit Backstop NTX Texture and Grid Tape Option

1. For sheathing substrates, apply the Dryvit Grid Tape along all joints in the sheathing, as well as inside corners, outside corners, and exposed edges at terminations that will not be covered with Dryvit AquaFlash.
2. Center the Dryvit Grid Tape on the sheathing joints, edges, etc. with the pressure sensitive adhesive backing in contact with the sheathing surface. Press into position with hand pressure until adhesion is achieved.
3. Apply only enough Dryvit Grid Tape as can be covered with Backstop NTX – Texture in the same day.
4. Mix the Backstop NTX – Texture material as described in Section 3.B.2. Using a stainless steel trowel or spatula, apply a layer of Backstop NTX – Texture over the Dryvit Grid Tape and spot all fastener heads – Figure 16. **NOTE: Dryvit Grid Tape is not necessary over fastener heads.**

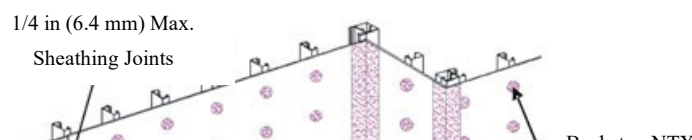

5. Allow to dry for a minimum of 2 hours or until dry to the touch. **NOTE: Cool, humid conditions may require longer drying times**
 - a. Because of the absorption characteristics, plywood substrates may require a second pass to fill any voids at the sheathing joints. After the first pass has dried, check the joints and spot any voids that may be present with additional Backstop NTX – Texture material and allow to dry.

NOTE: OSB sheathing requires that joints and fasteners be treated with Backstop NTX – Texture. A minimum of two (2) coats of Backstop NTX – Smooth are required for the field of the wall. Backstop NT - Texture is not recommended for application in the field of the board.

7. AIR/WATER-RESISTIVE BARRIER APPLICATION

A. Design Requirements

1. For Backstop NTX, ensure that the wall surface and ambient temperature are from 25 °F (-4 °C) minimum to 100 °F (38 °C) maximum at the time of Backstop NTX application. **WARNING: Do not apply the Dryvit materials in the rain. The underlying wall materials and substrate surface must be dry prior to applying the air/water-resistive barrier.**
2. Sheathing Substrates
 - a. Prior to applying the Backstop NTX over a sheathing substrate, check to ensure that:
 - 1) The sheathing is of a type listed in the Outsulation Masonry Veneer System Specification, DS977.
 - 2) The sheathing is structurally sound, free of loose material, voids, projections or other conditions that may interfere with the installation of the Outsulation Masonry Veneer System.
 - 3) The sheathing is clean, dry, and free of grease, oil, paint and other foreign material.
 - 4) Exterior grade gypsum sheathing shall not show signs of deterioration and facer shall be firmly bonded to the core.
 - 5) Plywood or OSB moisture content shall not exceed 19% as measured by a probe type moisture meter.
 - 6) There are no planar irregularities greater than 1/4 in (6.4 mm) within any 4 ft (1.2 m) radius. **SHEATHING WITH GAPS OR DAMAGE EXCEEDING 1/4 in (6.4 mm) IN ANY ONE DIRECTION MUST BE REPLACED. NOTE: Notify the general contractor and/or architect and/or owner of all discrepancies. Do not proceed until all unsatisfactory conditions have been corrected. NOTE: OSB sheathing requires that joints and fasteners be treated with Backstop NTX – Texture. Two (2) coats of Backstop NTX-Smooth are required for the field of the wall. Backstop NTX-Texture is not recommended for application in the field of the board.**
3. Concrete or Masonry Substrates

NOTE: Backstop NTX – Texture or Backstop NTX – Smooth (sprayed) are recommended for use over concrete and masonry.

 - a. Prior to applying the Backstop NTX – Texture or Backstop NTX – Smooth (sprayed) over a concrete or masonry substrate, check to ensure that:
 - 1) All cracks are repaired using appropriate procedures and materials.
 - 2) The substrate is structurally sound, free of loose material, voids, projections or other conditions that may interfere with the installation of the Outsulation Masonry Veneer System.

- 3) The substrate is clean, dry, free of grease, oil, paint, form release agents, efflorescence and other foreign materials that may inhibit adhesion.
- 4) There are no planar irregularities greater than 1/4 in (6.4 mm) within any 4 ft (1.2 m) radius.
- 5) Mortar joints that are NOT struck flush or heavily textured masonry units shall be skim coated with Dryvit Genesis prior to the application of Backstop NTX – Texture or Backstop NTX – Smooth (sprayed).
 - a) Mix Genesis in accordance with DS417.
 - b) With a stainless steel trowel, apply a coat of the Genesis mixture or Genesis DM mixture over the substrate to fill the mortar joints and surface texture to provide a uniform smooth surface for the application of the Backstop NTX Material.
 - c) Allow the skim coat to completely dry prior to applying the Backstop NTX – Texture or Backstop NTX – Smooth (sprayed).
 - d) **Genesis shall not be used for any other purpose with the Outsulation Masonry Veneer System.**

B. Usage Application Chart

Backstop NTX usage application chart is below.

BACKSTOP NTX (BSNTX) – TEXTURE, SMOOTH, AND SPRAY USAGE/APPLICATION CHART

			APPROX. COVERAGE PER PAIL	APPROX. COVERAGE PER DRUM
--	--	--	---------------------------	---------------------------

EXTERIOR GRADE GYPSUM SHEATHING

Joints ^a	BSNT-Texture	Trowel	300 lin. ft. (91 m)	
	BSNTX Smooth	Trowel or Spray	800 ft ² (75 m ²)	
	Dymonic 100	Putty Knife	308' of joint per gallon for a 1/4" x 1/4" (6 mm x 6 mm) joint	
	Backstop Flash and Fill	Putty Knife	20 oz (.59 l) SSG covers 15 - 17 ft ² (1.39 - 1.58 m ²) at 12 - 15 wet mils (0.30 – 0.38 mm)	
Face ^e	BSNTX Texture	Trowel, FoamPRO #58 Roller ^b , or Texture Sprayer	250-300 ft ² (23-28 m ²)	
	BSNT- Smooth ^{c,g}	1/2 in (12.7 mm) Nap Roller or	800 ft ² (75 m ²)	
Airless Spray		500-600 ft ² (46-56 m ²)	5,000-6,000 ft ² (465-557 m ²)	

FIBERGLASS FACED EXTERIOR GYPSUM SHEATHING

Joints ^a	BSNTX Texture	Trowel	300 lin. ft. (91 m)	
	BSNTX Smooth	Trowel	650 ft ² (60 m ²)	
Face ^e	BSNTX Texture	Trowel or Texture Sprayer	250-300 ft ² (23-28 m ²) [includes joints]	
	BSNT- Smooth ^{c,g}	3/4 in (19 mm) Nap Roller or	400 ft ² (X m ²)	
		Airless Spray	500-600 ft ² (46-56 m ²)	5,000-6,000 ft ² (465-557 m ²)

EXPOSURE 1, EXTERIOR GRADE, AND FIRE RETARDANT TREATED PLYWOOD; AND EXTERIOR CEMENT BOARD

Joints ^a	BSNTX Texture	Trowel	300 lin. ft. (91 m)	
	BSNTX Smooth	Trowel	650 ft ² (60 m ²)	
Face ^{e,i}	BSNTX Texture	Trowel, FoamPRO #58 Roller ^b or Texture Sprayer	250-300 ft ² (23-28 m ²)	
	BSNTX Smooth ^{c,g}	1/2 in (12.7 mm) Nap Roller or	650 ft ² (60 m ²)	
		Airless Spray	500-600 ft ² (46-56 m ²)	5,000-6,000 ft ² (465-557 m ²)

APA EXPOSURE 1 RATED ORIENTED STRAND BOARD (OSB)

Joints ^a	BSNTX Texture	Trowel	300 lin. ft. (91 m)	
	BSNTX Smooth	Trowel	650 ft ² (60 m ²)	
Face ^e	BSNT - Smooth ^h	1/2 in (12.7 mm) Nap Roller or Airless Spray	350-400 ft ² (33-37 m ²)	3,500-4,000 ft ² (325-372 m ²)

CONCRETE AND MASONRY^{d,g}

Face	BSNTX Texture	Trowel ^f	200-250 ft ² (19-23 m ²) ^f	
	BSNTX Texture	FoamPRO #58 Roller or Texture Sprayer	200-250 ft ² (19-23 m ²) ^f	
	BSNTX Smooth ^h	Airless Spray	300-500 ft ² (28-46 m ²)	3,000-5,000 ft ² (279-465 m ²)

a Tape the joints with Dryvit Grid Tape when using BSNTX Texture and with Aquaflash Mesh when using Backstop NTX Smooth – BSNTX Texture at screw heads.

b Up to 1 pint (16 oz) of water may be added to a 60 lb pail of Backstop NTX Texture for roller or spray applications only. The FoamPRO #58 roller cover (FoamPRO Mfg., Inc., www.foampromfg.com) is available at home supply stores.

c Due to variations in types of concrete/masonry, apply a 6 ft x 6 ft test area with coverage as indicated in the chart, before proceeding with the entire job. If there are voids in the substrate, particularly at the mortar joints, the job should be parged with Genesis®, 24 hours prior to BSNTX Texture application. Backstop NTX shall NOT be used as a skim coat for parging CMU joints or heavy textured units.

d Backstop NTX Texture (with up to 1 pint water addition per 60 lb. pail) or Smooth may be sprayed and backtrowelled/backrolled.

e Coverage may vary depending on the texture and porosity of the substrate. Coverage assumes a smooth, dense surface.

f Backstop NTX should be applied at the recommended coverage rates to form a continuous film free of voids, pinholes or other discontinuities. The following approximate mil thicknesses are recommended:

Backstop NTX Texture	13 DFT	20* WFT
Backstop NTX Smooth	9 DFT	14*

*Based on volume solids

Refer to Product Data Sheets for Complete Mixing and Application Instructions

C. Application of Backstop NTX

1. Dryvit Backstop NTX – Texture Application

NOTE: Backstop NTX Texture is NOT recommended for use over the face of OSB.

- a. General: Backstop NTX – Texture can be applied using a roller, trowel or texture spray equipment over the listed substrates, as noted in the usage chart above. Backstop NTX – Texture should be applied at the recommended coverage rate to achieve a continuous film at a minimum dry film thickness of approximately 13 mils (0.3).

- 1) Allow to dry for a minimum of 2 hours or until dry to the touch.

NOTE: Cool, humid conditions may require longer drying times

- a) Because of the absorption characteristics, plywood substrates may require a second pass to fill any voids at the sheathing joints. After the first pass has dried, check the joints and spot any voids that may be present with additional Backstop NTX – Texture material and allow to dry.

2. Roller Application

- a. Use a coarse, open-cell foam roller cover with a 3/8 in (9.5 mm) foam nap (FoamPRO #58 roller). Apply a uniform, continuous film of Backstop NTX – Texture over the entire surface of the sheathing, concrete or masonry, including the previously treated areas – Figure 17.

NOTE: If the roller pulls material back out of the sheathing joints, it indicates that the joint material is not sufficiently dry.

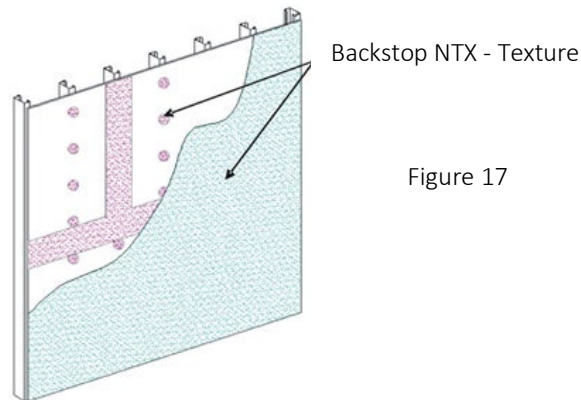

Figure 17

- b. For concrete and masonry, ensure that a continuous film of uniform thickness is applied across the entire surface and across mortar joints. Minimum two (2) coats are required allowing a minimum of two (2) hours between coats. Cool, damp weather may require longer time between coats.
 - c. While the Backstop NTX – Texture is still wet, using a trowel or spatula, smooth out the Backstop NTX – Texture around all window and door perimeters.
 - d. The Backstop NTX – Texture material should be applied in a uniform, continuous film at the recommended coverage rate. **NOTE: Substrates with a surface texture or high porosity will require additional material.**
- c. Trowel Application
 - 1) Spotting of fasteners is not necessary when applying Backstop NTX – Texture using a trowel. Allow to dry for a minimum of 2 hours or until dry to the touch.
 - 2) Using a stainless steel trowel, apply a continuous coating of Backstop NTX – Texture material onto the entire surface. The material should be applied at a smooth, uniform, continuous film approximately equal to the thickness of the aggregate.
 - d. Spray/Back-Rolling Application
 - 1) Using a hand held hopper gun or other suitable texture spray equipment; spray a layer of Backstop NTX – Texture onto the wall surface. Using a coarse, open-cell foam roller cover with a 3/8 in (9.5 mm) foam nap (FoamPro #58 roller), roll the material to create a smooth continuous film.
NOTE: If the roller pulls material back out of the sheathing joints, it indicates that the joint material is not sufficiently dry.

- 2) Because of the absorption characteristics, plywood substrates may require a second pass to fill any voids at the sheathing joints. After the first pass has dried, check the joints and spot any voids that may be present with additional Backstop NTX – Texture material and allow to dry.
- 3) While Backstop NTX – Texture is still wet, using a trowel or spatula, smooth out the Backstop NT – Texture around all window and door perimeters.
- 4) Backstop NTX – Texture material should be applied in a uniform, continuous film at the recommended coverage rate.

NOTE: Substrates with a surface texture or high porosity will require additional material.

- e. Allow the Backstop NTX – Texture to completely dry prior to installation of the Outsulation Masonry Veneer System.

3. Backstop NTX – Smooth Application

- a. General: Dryvit Backstop NTX – Smooth can be applied using a roller or sprayed and back-rolled over the acceptable sheathing substrates. **NOTE: OSB sheathing requires that joint and fasteners be treated with Backstop NTX – Texture. A minimum of two (2) coats of Backstop NTX – Smooth are required for the field of the wall. Backstop NTX – Texture is not recommended for application in the field of the board.**
- b. Roller Application
 - 1) Using the appropriate nap roller (see Usage Application Chart), apply the Backstop NTX – Smooth over the entire wall surface, including previously treated joints. **NOTE: If the roller pulls material back out of the sheathing joints, it indicates that the joint material is not sufficiently dry.**
 - 2) Backstop NTX – Smooth material should be applied in a uniform, continuous film at the recommended coverage rate – Figure 18. **NOTE: Sheathing substrates with a surface texture or high porosity will require additional material.**

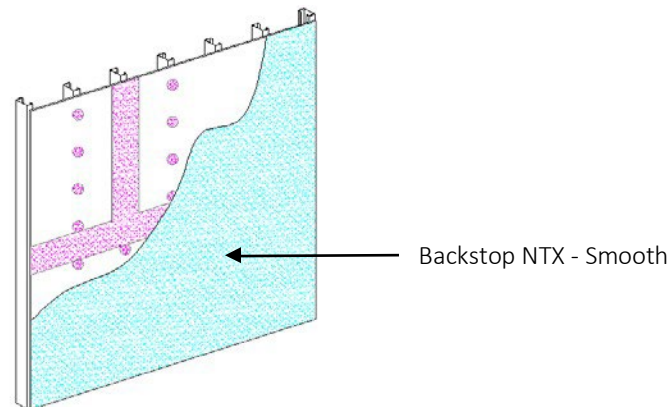

Figure 18

- c. Spray/Back-Rolling Application
 - 1) Backstop NTX – Smooth may be applied to the wall using spray equipment and back-rolled using the appropriate nap roller (see Usage Application Chart).
 - 2) Allow the Backstop NTX – Smooth to completely dry. Check the wall to ensure that the Backstop NTX – Smooth is continuous and spot any visible voids with additional Backstop NTX – Smooth material.

8. ACCESSORIES

A. Installation of the Dryvit Drainage Strip in Dryvit Exterior Insulation and Finish System (EIFS) Assemblies

1. Dryvit Drainage Strip

- a. Dryvit Drainage Strip shall be used at the base of the walls and shall be installed at the heads of all penetrations and at expansion/control joints in EIFS assemblies as shown in Outsulation Masonry Veneer System Installation Details, [DS978](#).
- b. Using a chalk line, strike a level line at the base of the wall, head of opening or expansion/control joint to use as reference in applying the Dryvit Drainage Strip.
- c. Install the Dryvit Drainage Strip by applying dabs of Tremco TREMGrip™ adhesive at 12 in (300 mm) on center on the dry Backstop NTX air/water-resistive barrier.

- d. Position the Dryvit Drainage Strip along the chalk line and press firmly against the substrate to ensure firm contact between the adhesive and the wall surface. Staples or other fasteners may be used if necessary to maintain position until the adhesive sets.
- B. Installation of Pre-Based Starter Boards in Dryvit Exterior Insulation and Finish System (EIFS) Assemblies
1. Pre-Based Starter Boards
 - a. Dryvit Pre-Based Starter Boards manufactured with Dryvit Primus base coat only can be used at the base of walls and can be installed at the heads of all penetrations and at expansion/control joints in EIFS assemblies in place of Dryvit Drainage Strip and as shown in Outsulation Masonry Veneer System Installation Details, [DS978](#).
 - b. Install Pre-Based Starter Boards in accordance with Dryvit document DS854.

9. INSULATION BOARD INSTALLATION

- A. System Terminations
1. Attach Detail Mesh around the perimeter of all openings, penetrations, and other system terminations by stapling or applying a ribbon of adhesive mixture on the substrate and embedding the Detail Mesh into the wet mixture.
NOTE: Back wrapping is not required at the base of the wall when using the Dryvit Drainage Strip.
 2. Position the Detail Mesh so that a minimum of 2 1/2 in (64 mm) will extend onto the face of the insulation board. Keep the mesh, which is not embedded, clean.
- B. Inspection of the Insulation Board
1. Prior to installing the insulation board, it shall be checked to ensure that:
 - a. It is shipped in a clear polyethylene bag bearing the Dryvit name. In addition, the lot number of the insulation board shall be visible on the outside of the bag. Insulation board shall be obtained from Dryvit or its authorized distributors, and made exclusively by manufacturers listed by Dryvit.
 - b. One edge of each board shall bear the word Dryvit, the plant identification number of the block molder, the appropriate model code report number, and the name of the third party quality control agency with corresponding number. In addition, one board in each bag shall bear the same markings on the face.
 - c. The insulation board measures a maximum of 2 ft (0.6 m) by 4 ft (1.2 m) with a minimum thickness of 1 in (25 mm). 3/4 in (19 mm) thick EPS may be used in small localized areas.
 - d. The insulation board meets the following tolerances:
 - 1) Length: Plus or minus 1/16 in (1.6 mm).
 - 2) Width: Plus or minus 1/16 in (1.6 mm).
 - 3) Thickness: Plus or minus 1/16 in (1.6 mm). For boards greater than 1 in (25 mm), plus 1/16 in (1.6 mm). minus 0 for boards less than or equal to 1 in (25 mm).
 - 4) Squareness: Shall not deviate from square by more than 1/32 in (0.8 mm) in 12 in (305 mm) of total length or width.
 - 5) Edge Trueness: Shall not deviate more than 1/32 in (0.8 mm) in 12 in (305 mm).
 - 6) Face Flatness: Shall not exhibit any bowing of more than 1/32 in (0.8 mm) in the length.**WARNING: Any insulation board not meeting the above requirements should be rejected and not installed.**
- C. Methods of Applying the Dryvit Adhesive
1. Mix the Dryvit adhesive, Primus, in accordance with Section 3.C
 - a. Notched Trowel Method
 - 1) With a notched trowel, 3/8 in (9.5 mm) wide, 1/2 in (12.7 mm) deep notches spaced 1 1/2 in (38 mm) apart, apply the adhesive mixture to the backside of the insulation board. Holding the trowel at a 45° angle, apply firm pressure to the insulation board in order to scrape the excess adhesive from between the adhesive beads. **NOTE: Apply the adhesive so that the ribbons run vertically when the insulation board is placed on the wall.**

D. Insulation Board Installation

1. Prior to installing the insulation board, ensure that the surface of the Backstop NTX is uniform in thickness, continuous, clean, dry and free of any foreign materials that will affect adhesion of the insulation board.
2. Begin installation of the insulation board from a permanent or temporary support.
3. When sheathing is used as a substrate, use a 12 in (305 mm) high by 4 ft (1.2 m) long piece of insulation board as a starter row at the base of the wall. This will help minimize the insulation board joints from coinciding with the sheathing joints. Offset the insulation board joints from the sheathing joints a minimum of 8 in (203 mm) in both vertical and horizontal directions. Install the insulation boards with their long edges oriented horizontally.
4. Apply the adhesive to the insulation board as described in Section 9.C.
 - a. Butter the edge of the insulation board at all terminations in order to properly embed the previously installed Detail Mesh used for back wrapping. Back wrapping is necessary to provide appropriate fire performance and to create the proper surface for application of sealant.
NOTE: The application of the adhesive mixture to the edge of the insulation board is only done when wrapping with the Detail Mesh.
5. Position the insulation board horizontally on the substrate. Press the board gently to the substrate and slide it into position. Apply firm pressure over the entire surface of the insulation board to ensure uniform contact and high initial grab.
6. Using a margin trowel, clean the insulation board edges of any adhesive mixture. Ensure that the insulation board joints are butted tightly and faces are level and flush. **CAUTION: Do not allow adhesive to remain in board joints.**
7. Install subsequent rows of insulation board in a running bond pattern (vertical joints staggered).
8. With factory edges exposed, stagger vertical joints at inside and outside corners. Make sure the corners are straight and plumb.
9. To ensure an overall flat surface, tamp the insulation board surface with a board that overlaps two to four rows of insulation.
10. If for any reason the insulation board joints are not butted tightly, slivers of insulation board must be installed to fill any gaps. ALL GAPS GREATER THAN 1/16 in (1.6 mm) MUST BE SLIVERED. **Tip: In order to create a tight fit, it is recommended that a wider joint be cut with a hot groover or similar tool to allow for a more precise fitting sliver. Do not install adhesive on sliver edges.**
11. Windows, Doors, Mechanical Equipment and all Wall Penetrations
 - a. Option 1
 - 1) At openings, align the insulation boards so that the edges (vertical and horizontal joints) do not coincide with the corners of the opening (refer to Outsulation Masonry Veneer System Installation Details, [DS978](#)).
 - 2) Attach Detail Mesh around the perimeter of the opening as described in Section 9.A.
 - 3) Hold the insulation board back from the window/door frame or mechanical equipment to allow for differential movement, proper system edge preparation, and sealant installation as shown in the Outsulation Masonry Veneer System Installation Details, [DS978](#).
 - b. Option 2 – Installation of J Track at heads of all openings [length not to exceed 10 ft (0.3 m)].
Tip: It is recommended to use a 3/4 in (19 mm) casing bead as manufactured by Plastic Components – item number 1075.
 - 1) Because insulation board joints cannot align with corners of openings, first cut L-shaped pieces of insulation board for the corners of the opening. Then measure and cut the insulation board to the proper length to fit between the corner pieces over the opening. Insulation board shall be notched to receive J track as shown in the Outsulation Masonry Veneer System Installation Details, [DS978](#).
 - 2) Mix the adhesive material as described in Section 3.C.
 - 3) Cut the Detail Mesh to a working length.
 - 4) Apply a ribbon of adhesive mixture on the air/water-resistive barrier/substrate and position the Detail Mesh in the wet mixture allowing for a 2 1/2 in (64 mm) minimum overlap onto the face of the insulation board. Keep the mesh, which is not embedded, clean.

- 5) Apply the adhesive mixture to the backside of the insulation board in accordance with Section 9.D and position on the wall. Press gently and slide into position applying uniform pressure to ensure full contact and high initial grab.
- 6) Using a margin trowel, remove any adhesive from the edges of the insulation boards that will abut other insulation boards. **CAUTION: Do not allow adhesive to remain in board joints. Ensure that the insulation board joints are abutted tightly, and are level and flush.**
- 7) Measure and cut J Track so that it extends 6 in (152 mm) beyond the edges of the opening as shown in Outsulation Masonry Veneer Installation Details DS978.
- 8) Install the J Track by applying a continuous bead of Tremco TREMGrip adhesive on the wall side of the vertical nailing flange of the track and position over the notched insulation board. Press firmly against the substrate to ensure firm and continuous contact between the adhesive and the wall surface.
- 9) Secure the track to the wall using corrosion resistant fasteners attached into the underlying framing members. **NOTE: It is recommended that the surface of the track be lightly sanded to improve adhesion.**
- 10) Install the AquaFlash System, or Backstop NTX and Grid Tape on the flange of the J Track and the adjacent wall in order to ensure water-tightness at the flange/wall interface. See Section 4 for proper application.

12. Expansion Joints in EIF System

- a. Attach Detail Mesh around the perimeter of the opening as described in Section 9.A.
- b. When abutting dissimilar materials, leave a minimum 3/4 in (19 mm) separation between the insulation board and abutting material to allow for differential movement, proper system edge preparation and sealant installation.
- c. When the Outsulation Masonry Veneer System is installed at a substrate transition, leave a minimum 3/4 in (19 mm) separation between the insulation boards to allow for differential movement, proper system edge preparation and sealant installation.

13. **IMPORTANT:** Once the insulation board and Detail Mesh are in place, wait a minimum of 24 hours prior to working on the surface of the insulation board to prevent any movement which may weaken the bond of the adhesive mixture to the substrate. **NOTE: Be sure to protect the installed insulation board from rain, freezing or inclement weather for a period of 24 hours.**

14. Any irregularities in the insulation board surface must be sanded flat. Sanding is accomplished with a light circular motion. **The entire wall area must be sanded.** Use grade 20 grit sandpaper or coarser, in conjunction with hand, electric or air rasps. **NOTE: Do not sand parallel to the insulation board joints. CAUTION: The contractor shall take precautions to contain EPS dust from rasping operation in accordance with contract documents. Use of vacuum rasps are recommended to minimize introduction of EPS dust into the environment.**

15. Remove all loose pieces of insulation board and dust from the sanding operation using a brush, broom, or compressed air. Use OSHA required masks to protect against inhaling EPS dust.

16. All Detail Mesh that was previously installed for back wrapping the insulation board shall be embedded in the base material mixture at this time.

- a. With a stainless steel trowel, apply any of Dryvit's cementitious base material mixture to the face (and edge if not previously coated) of the insulation board and embed the Detail Mesh in the wet mixture.

18. Where Corner Mesh is specified for additional impact resistance at outside corners, the Corner Mesh shall be embedded in the base coat mixture and allowed to set prior to installing the overall reinforced base coat over the face of the wall.

19. Corners of all openings such as windows, doors, mechanical equipment and all penetrations shall be reinforced with Detail Mesh placed diagonally to the opening as illustrated in Figure 19.

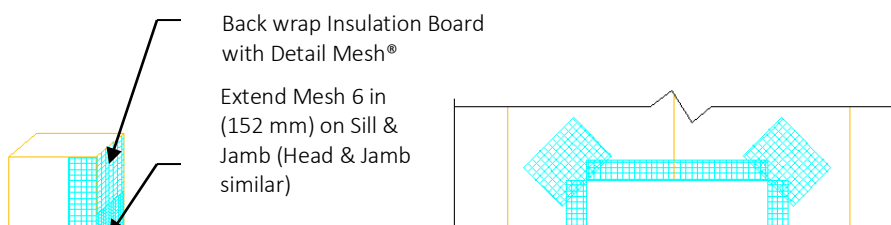

Dryvit Detail Mesh
9 1/2 in (241 mm) X
12 in (305 mm) (typ.)

10. INSTALLATION OF REINFORCING MESH AND BASE COAT

A. General

1. **Do not apply the Dryvit materials in the rain. The insulation board must be dry prior to applying the base coat material.**
2. Prior to installing the reinforced base coat, inspect the surface of the insulation board for:
 - a. Flatness: Use a minimum 8 ft (2.4 m) straight edge. Sand any high areas and out-of-plane board joints flat, as described in Section 9.D.14 and 15. **CAUTION: Do not build up low areas with base coat mixture to form a flat surface.**
 - b. Damage and foreign materials: correct deficiencies as necessary.
 - c. Surface degradation due to weathering or UV, visible as discoloration. Sand affected areas to remove deterioration while maintaining the flatness of the surface.

B. Mix the base coat material as described in Section 3.C

C. Prior to installing the reinforcing mesh, it should be inspected to ensure that it has been furnished by Dryvit

1. Dryvit reinforcing mesh is available in the following widths and lengths for the OMVS:
 - a. Intermediate - 48 in x 150 ft (1.2 m x 45.7 m)
 - b. Detail— 9 1/2 in x 150 ft (241 mm x 45.7 m)
2. It shall be colored blue for product identification bearing the Dryvit logo.

D. Base Coat Application

1. Primus Base Coat

- a. The base coat shall be applied such that the resulting overall minimum base coat thickness is sufficient to **fully embed** the reinforcing mesh. The recommended method is to apply the base coat in two (2) passes.
- b. Double pass method (recommended)
 - 1) Using a stainless steel trowel, apply the base coat mixture on the entire surface of the insulation board to an area slightly larger than the width and length of a piece of reinforcing mesh, in a uniform thickness of 1/16 in (1.6 mm).
NOTE: The reinforcing mesh may be installed either vertically or horizontally.
 - 2) Immediately place the Intermediate reinforcing mesh against the wet base coat mixture. With the curve of the mesh against the wall, trowel from the center to the edges avoiding wrinkles, until the mesh is fully embedded and not visible. Trowel smooth to a uniform thickness slightly more than the thickness of the reinforcing mesh. **NOTE: The reinforcing mesh shall be continuous at corners and mesh edges lapped not less than 2 1/2 in (64 mm). Do not lap the reinforcing mesh within 8 in (203 mm) of a corner. Tip: Corners and edges normally require light strokes with a small damp brush to smooth out irregularities.**
 - 3) Allow the base coat mixture to take up until firm to the touch. Trowel a second tight coat of the base coat mixture over the first coat to **fully cover** the reinforcing mesh - Figure 20. The result should be such that the reinforcing mesh is approximately centered within the base coat thickness. Do not allow the first pass to completely dry prior to the second pass application or an excessive amount of base coat mixture will be necessary to fully coat the wall surface.

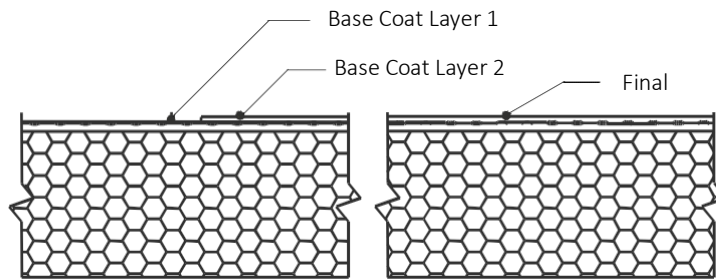

Figure 20

- c. Single pass method (optional)
- 1) Using a stainless steel trowel, apply the base coat mixture on the entire surface of the insulation board to an area slightly larger than the width and length of a piece of reinforcing mesh, in a uniform thickness of 1/16 in (1.6 mm).
NOTE: The intermediate reinforcing mesh may be installed either vertically or horizontally. Horizontal orientation will turn through inside and outside corners more easily.
 - 2) Immediately place the reinforcing mesh against the wet base coat mixture. With the curve of the mesh against the wall, trowel from the center to the edges avoiding wrinkles, until the mesh is fully embedded and not visible. Trowel smooth to a uniform thickness slightly more than the thickness of the reinforcing mesh.
NOTE: The intermediate reinforcing mesh shall be continuous at inside and outside corners and mesh edges lapped not less than 2 1/2 in (64 mm). Do not lap the reinforcing mesh within 8 in (203 mm) of a corner. Tip: Corners and edges normally require light strokes with a small damp brush to smooth out irregularities.
- d. Protect completed work from water penetration and runoff.
- e. Allow the base coat to be fully dry and cured a minimum of 24 hours before proceeding with application of the Modified Primus Skim Coat Substrate Preparation layer followed by the Modified Primus Adhesive for Manufactured Stone Masonry Veneer (See Section 3.D for mixing instructions). Cool, damp conditions may require longer drying times. Do not apply the Modified Primus Skim Coat to a wet or damp base coat. Apply Modified Primus Adhesive to wet Skim Coat surface.

11. MANUFACTURED STONE MASONRY VENEER MATERIAL

- A. The Outsulation Masonry Veneer System is intended for use on vertical above grade walls.
1. Wall assembly to which the Manufactured Stone Masonry shall be adhered shall be structurally engineered to limit deflection to 1/360 of the span.
 2. In framed wall assemblies, framing members such as vertical king studs, horizontal lintels and horizontal headers at wall penetrations shall be structurally engineered to limit deflection to 1/600 of the span.
- B. Manufactured Stone Masonry Veneer Material Requirements:
1. Shall be recognized in a current ICC ES Evaluation Report demonstrating compliance with ICC-ES AC51 Acceptance Criteria for Adhered Manufactured Stone Masonry Veneer.
 2. Units shall have a minimum thickness of ¼ in. [6 mm] except those parts of a unit within 0.5 in. [13 mm] of the unit perimeter.
 3. The average thickness of each unit shall be less than or equal to 2 5/8 in. [ft2].
 4. Units shall not exceed 36 in. [915 mm] in any face dimension and shall not exceed more than 5 ft² [0.5 m²] in total face area.
 5. Shall develop a shear bond strength with the Dryvit Primus Adhesive of not less than 50 psi (350 kPa) when tested in accordance with Test Method ASTM C482.
 6. Shall have a maximum allowable saturated weight of 15 lb/ft² (70 kg.m²).
 7. Maximum allowable height above grade shall comply with the Outsulation Masonry Veneer System wind load testing data and in accordance with selected Manufactured Stone Masonry Veneer material

manufacturer recommendations and limitations specific to climate zone and exposure. Consult with Dryvit Technical Services at 800-556-7752 / www.dryvit.com.

8. Allowable plan radius geometry is directly dependent to the relationship of the plan radius to width of the selected veneer unit in order to maintain proper adhesive thickness and overall adhesion contact to the substrate. For radius applications, consult with Dryvit Technical Services at 800-556-7752.
- C. Mortar for Joint Treatment within the Manufactured Stone Masonry Veneer Requirements:
1. Shall comply with ASTM C 270 Standard Specification for Mortar for Unit Masonry and ASTM C 1330 – Standard Specification for Preblended Dry Mortar Mix for Unit Masonry.
 2. Shall comply with selected Manufactured Stone Masonry Veneer material manufacturer’s requirements for the specific veneer installed.

12. MANUFACTURED STONE MASONRY VENEER INSTALLATION

- A. Substrates for the Outsulation Masonry Veneer System Installation
1. Acceptable substrates for the Outsulation Masonry Veneer System include:
 - a. Exterior sheathing having a water-resistant core with fiberglass mat facers meeting ASTM C 1177. Minimum thickness 1/2".
 - b. Exterior fiber reinforced cement or calcium silicate boards. Minimum thickness 1/2".
 - c. APA Exterior or Exposure 1 Rated Plywood, Grade C-D or better, nominal 1/2 in (12.7 mm), minimum, installed with the C face out.
 - d. APA Exterior or Exposure 1 Fire Retardant Treated (FRT) Plywood, Grade C-D or better, nominal 1/2 in (12.7 mm), minimum, installed with the C face out.
 - e. APA Exposure 1 Rated Oriented Strand Board (OSB) nominal 1/2 in (12.7 mm), minimum. NOTE: Applications over OSB sheathing requires a minimum of 2 coats of Backstop NTX – Smooth. Backstop NTX – Texture is not recommended for the field of wall application over OSB.
 - f. Unglazed brick, cement plaster, concrete or masonry.
 2. The substrate shall be free of foreign materials such as oil, dust, dirt, form-release agents, efflorescence, paint, wax, water repellents, moisture, frost, and any other materials that inhibit adhesion.
 3. The substrate shall be flat and level to ¼ in (6mm) within a 4 ft (1.2 m) radius, and be free of imperfections, recesses or protrusions that would interfere with the Manufactured Stone Masonry Veneer application.
 4. The Intermediate Reinforcing Mesh shall be completely embedded in the Dryvit Primus Base Coat.
 5. Ensure the Dryvit Primus Base Coat is fully dry and cured a minimum of 24 hours, or longer, depending on weather conditions before proceeding with application of the Modified Primus Skim Coat Substrate Preparation layer (see Section 12.B). Cool, damp conditions may require longer drying times. Do not apply the Modified Primus Skim Coat to a wet or damp base coat.
 6. The Dryvit Primus Base Coat shall be free of any imperfections prior to applying the Dryvit Modified Primus Skim Coat Substrate Preparation layer in advance of adhering the Manufactured Stone Masonry Veneer.
- B. Application of Manufactured Stone Masonry Veneer
1. Inspect Manufactured Stone Masonry Veneer and mortar for joint treatment (where applicable) and verify as acceptable for use based on the selected Manufactured Stone Masonry Veneer and mortar for joint treatment current application instructions and requirements.
 2. Clean and prepare surfaces of the Manufactured Stone Masonry Veneer units thoroughly prior to installation.
 3. Coordinate installation requirements for selected Manufactured Stone Masonry Veneer manufacturer as applicable for applications as outlined herein including but not limited to veneer unit delivery, handling, storage, protection, inspection, preparation, layout, alignment, expansion joints, size, area, weight criteria, curing, mortaring (where applicable), cleaning and sealing (as required).
 4. EIF System Base Coat Substrate Surface for Application
 - a. The Dryvit EIF System Base Coat substrate surface to receive the application of Dryvit Modified Primus Skim Coat Preparation layer must be thoroughly dry, clean, smooth and free of any condition that will hinder adhesion.
 - b. Clean loose dust or dirt from the Dryvit EIF System Base Coat surface by wiping with a clean, dry cloth or brush.
 5. Apply Skim Coat Preparation Layer

- a. See Section 3.D.1. for mixing of Dryvit Primus for application as a Skim Coat for the preparation of the Dryvit EIF System Base Coat.
 - b. Using a steel trowel, apply a tight skim coat to the surface of the substrate, approximately 1/32" to 1/16" thick.
 - c. Apply the Modified Primus Skim Coat in a workable area so the Modified Primus Skim Coat DOES NOT 'skim' over in advance of adhering the veneer units.
 - d. Allow the Modified Primus Skim Coat to set for 1-2 minutes. The Primus Skim Coat must remain wet when adhering the veneer units.
6. Apply Adhesive to the Veneer Units
- a. Apply the Modified Primus Adhesive to the back of the selected Manufactured Stone Masonry Veneer unit in a continuous layer with a thickness of 1/4" – 3/8" covering it completely leaving no voids, pockets or gaps when applied to the wet Primus Base Coat Substrate Preparation surface. **See Section 3.D.1. for mixing of Dryvit Primus for application as the adhesive. The Dryvit Modified Primus Adhesive has specific mixing requirements**
 - b. Apply the veneer unit to the wet Skim Coat on the substrate.
 - c. Remove adhesive from between adhered veneer unit(s) as needed.
7. Mortar for Joint Treatment (where applicable)
- a. Follow instructions of selected Manufactured Stone Masonry Veneer manufacturer if mortar for joint treatment is required.

13. DIRECT APPLIED MANUFACTURED STONE MASONRY VENEER

- A. When Manufactured Stone Masonry Veneer is to be direct-applied, application must be as follows:
1. The substrate shall be free of foreign materials such as oil, dust, dirt, form-release agents, efflorescence, paint, wax, water repellents, moisture, frost, and any other materials that inhibit adhesion.
 2. The substrate shall be flat and level to ¼ in (6mm) within a 4 ft (1.2 m) radius, and be free of imperfections, recesses or protrusions that would interfere with the Manufactured Stone Masonry Veneer application.
 3. Where applicable, the Intermediate Reinforcing Mesh shall be completely embedded in the Dryvit Primus Base Coat.
 4. Where applicable, the Dryvit Primus Base Coat shall be fully dried (a minimum of 24 hours, or longer, depending on weather conditions).
 5. Where applicable, the Dryvit Primus Base Coat shall be free of any imperfections prior to applying the Dryvit Modified Primus Skim Coat Substrate Preparation layer in advance of adhering the Manufactured Stone Masonry Veneer.
 6. The Manufactured Stone Masonry Veneer must meet all the criteria and requirements of Section 11.
 7. Installation of the Manufactured Stone Masonry Veneer shall follow steps in Section 12.B 1, 2, 3, 5, 6, and 7
 8. Acceptable substrates include:
 - a. Unpainted Precast or Placed Concrete
 - 1) Shall have cured a minimum of 28 days.
 - 2) Remove form release agents and clean surface of all contaminants.
 - 3) Apply Genesis mixture referenced herein above as a leveling coat as required to provide a smooth level base for the masonry veneer direct application. Application thickness shall not exceed 1/8 in (3.2 mm) in a single pass (as applicable).
 - 4) Allow the Dryvit Genesis mixture to cure a minimum of 24 hours until completely dry. Cool, humid conditions may require longer cure times.
 - 5) The surface shall be free of any imperfections prior to applying the Dryvit Modified Primus Skim Coat Substrate Preparation layer.

- 6) The Dryvit Modified Primus Skim Coat Substrate Preparation layer shall be applied in advance of adhering the Manufactured Stone Masonry Veneer.
- b. Unpainted Concrete and Brick Masonry Units
- 1) Mortar joints shall have cured a minimum of 7 days.
 - 2) Apply a continuous layer of Genesis mixture as referenced herein above over the entire wall surface to fill voids, level mortar joints and provide a smooth level base for the masonry veneer application. Application thickness shall not exceed 1/8 in (3.2 mm) in a single pass.
 - 3) Allow the Dryvit Genesis Leveling Coat mixture to cure a minimum of 24 hours until completely dry. Cool, humid conditions may require longer cure times.
 - 4) The surface shall be free of any imperfections prior to applying the Dryvit Modified Primus Skim Coat Substrate Preparation layer.
 - 5) The Dryvit Modified Primus Skim Coat Substrate Preparation layer shall be applied in advance of adhering the Manufactured Stone Masonry Veneer.
- d. Insulated Concrete Form (ICF)
- 1) Prepare ICF surface by sanding / rasping and cleaning.
 - 2) Apply Genesis mixture referenced herein above as a leveling coat as required to provide a smooth level base for the masonry veneer direct application. Application thickness shall not exceed 1/8 in (3.2 mm) in a single pass (as applicable).
 - 3) Allow the Dryvit Genesis mixture to cure a minimum of 24 hours until completely dry. Cool, humid conditions may require longer cure times.
 - 4) Dryvit Intermediate Reinforcing Mesh shall be completely embedded in Dryvit Genesis Base Coat which is applied to the ICF surface.
 - 5) Allow the Dryvit Primus Base Coat mixture to cure a minimum of 24 hours until completely dry. Cool, humid conditions may require longer cure times.
 - 6) The Dryvit Primus Base Coat shall be free of any imperfections prior to applying the Dryvit Modified Primus Skim Coat preparation layer
 - 7) The Dryvit Modified Primus Skim Coat Substrate Preparation layer shall be applied in advance of adhering the Manufactured Stone Masonry Veneer.
- e. Conventional Cement Stucco
- 1) Shall have cured a minimum of 7 days.
 - 2) Stucco shall comply with ASTM C926 and Metal Lath shall comply with ASTM C847 and ASTM C1063.
 - 3) The stucco shall be free of any imperfections prior to applying the Dryvit Modified Primus Skim Coat preparation layer.
 - 4) The Dryvit Modified Primus Skim Coat Substrate Preparation layer shall be applied in advance of adhering the Manufactured Stone Masonry Veneer.
- c. Cement Board
- 1) Section 4, 5 and 6 herein above for rough opening preparation, expansion joint treatment and sheathing board treatment shall apply. Manufactured Stone Masonry Veneer over Cement Board shall be limited to a maximum 20 ft in height.
 - 2) Install cement board over the treated sheathing and Dryvit MD Spacers, or equivalent (see Cement Board MD Finish System details, DS190). Treat joints with detail mesh and Primus Base Coat.

- 3)
- 4) Apply a layer of Dryvit Intermediate Reinforcing Mesh embedded in Dryvit Primus Base Coat to the cement board substrate surface.
- 5) Allow the Dryvit Primus Base Coat mixture to cure a minimum of 24 hours until completely dry. Cool, humid conditions may require longer cure times.
- 6) The surface shall be free of any imperfections prior to applying the Dryvit Modified Primus Skim Coat Substrate Preparation layer.
- 7) The Dryvit Modified Primus Skim Coat Substrate Preparation layer shall be applied in advance of adhering the Manufactured Stone Masonry Veneer.

14. SEALANT JOINT PREPARATION

- A. For sealant applied to manufactured stone masonry veneer, refer to sealant manufacturer's and selected Manufactured Stone Masonry Veneer manufacturer's installation instructions for the proper application of the sealant and sealant primer.
- B. In the event sealant is to be adhered to the EIF system base coat surface, refer to Dryvit document DS153.

15. MAINTENANCE AND REPAIR

- A. Refer to DryvitCARE EIFS Repair Procedures, [DS498](#), and manufacturer care instructions for the selected Manufactured Stone Masonry Veneer.

Information contained in this product sheet conforms to the standard detail recommendations and specifications for the installation of Dryvit products as of the date of publication of this document and is presented in good faith. Dryvit assumes no liability, expressed or implied, as to the architecture, engineering or workmanship of any project. To ensure that you are using the latest, most complete information, contact Dryvit.

For more information on Dryvit or Continuous Insulation, [click here](#).

Printed in USA. Issued 9.1.2022
©Dryvit. 2022

0922/DS976

Tremco Construction Products Group (CPG) brings together Tremco CPG Inc. and its Dryvit and Nudura brands; Willseal; Prebuck LLC; Tremco Barrier Solutions, Inc.; Weatherproofing Technologies, Inc. and its Pure Air Control Services and Canam Building Envelope Specialists offerings; and Weatherproofing Technologies Canada, Inc.



dryvit.com | 800.556.7752



Construction Products Group

3735 Green Rd. | Beachwood, OH 44122
800.321.7906 | tremcocpg.com